

Operating Instructions (EN)

MODELS:

Sport

20"-26" Disk

25" Cylindrical

20", 24" & 28" EDGE

Carbon

26"-28" Disk

25"-29" Cylindrical

24"-28" EDGE

Hero

30", 32" & 34" Disk

29"-33" Cylindrical

28"-32" EDGE

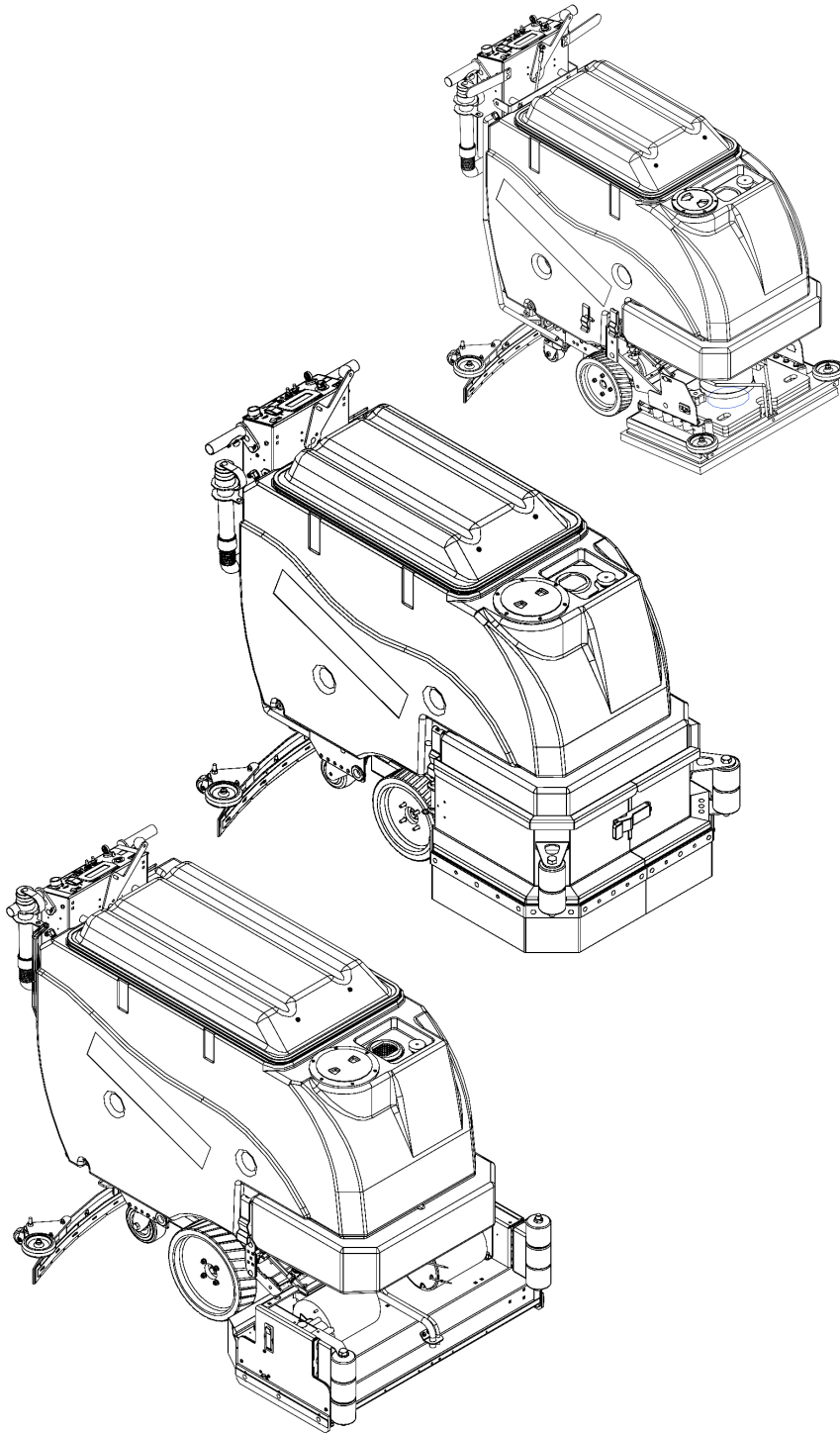

Read these Instructions before using the machine.



Read these Safety Messages before using the machine.

INTRODUCTION

This manual is furnished with each new machine. This manual will allow the Operator to get the best performance out of your RPS manufactured Scrubber-Drier, Sweeper, Burnisher, or Orbital Scrubber. Read this manual thoroughly before operating or servicing the machine.

This machine will provide excellent performance, but the best results will be obtained at the most minimum costs if:

- The machine is regularly maintained - per the Authorized Local Distributor.
- The machine is operated with reasonable care and caution.
- The machine is maintained with manufacturer supplied parts.

LOCATE SERIAL NUMBER

The serial number of your machine is located on the lower half of the control panel of the machine.

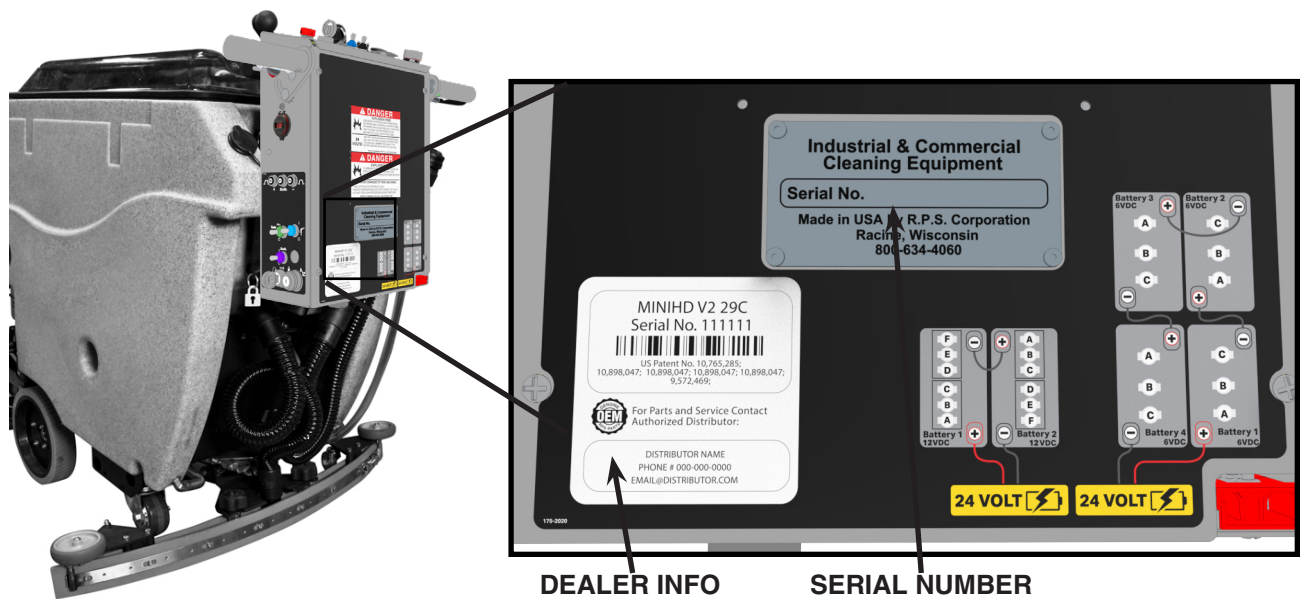

AS OUR POLICY IS ONE OF CONSTANT IMPROVEMENT - ALL INFORMATION AND SPECIFICATIONS ARE SUBJECT TO CHANGE WITHOUT NOTICE.

TABLE OF CONTENTS



| | | | |
|---|----|---|----|
| Introduction..... | 2 | Charge Batteries..... | 30 |
| Locate Serial Number..... | 2 | Battery Chargers..... | 31 |
| Table Of Contents..... | 3 | PM Sheet..... | 32 |
| Safety Messages..... | 4 | Military grade central command - status light codes | 34 |
| Safety Labels..... | 6 | Touch Screen Error Codes..... | 35 |
| Central command Dashboard controls..... | 7 | Military grade schematic | 38 |
| Central Command Side Panel Controls..... | 8 | touch screen schematics..... | 39 |
| Touch Screen (Optional)..... | 9 | SPORT Common Wear Parts..... | 42 |
| Touch Screen Symbols (Optional)..... | 10 | Round Disk Brushes:..... | 42 |
| Touch Screen Zone Operation (Optional)..... | 11 | Round Disk Pads:..... | 42 |
| Touch Screen Zone Programming (Optional)..... | 12 | Cylindrical Brushes:..... | 42 |
| Battery Setup..... | 13 | EDGE Pads and Screens:..... | 42 |
| Install Squeegee..... | 14 | EDGE Grip Face:..... | 43 |
| Adjust Squeegee..... | 15 | v2 Squeegee Blade Kits & Complete Squeegee Assemblies:..... | 43 |
| Remove From Battery Charger..... | 16 | CARBON Common Wear Parts..... | 44 |
| Transportation - Forward..... | 17 | Round Disk Brushes:..... | 44 |
| Transportation - Reverse..... | 18 | Round Disk Pads:..... | 44 |
| Fill Solution Tank..... | 19 | Cylindrical Brushes:..... | 44 |
| Operation - Scrubbing..... | 20 | EDGE Pads and Screens:..... | 44 |
| Draining Recovery Tank..... | 21 | EDGE Grip Face:..... | 45 |
| Draining Solution Tank..... | 22 | v2 Squeegee Blade Kits & Complete Squeegee Assemblies:..... | 45 |
| Flushing Recovery Tank..... | 23 | Hero Common Wear Parts..... | 46 |
| Clean Drain Saver..... | 24 | Round Disk Brushes:..... | 46 |
| Clean Cylindrical Hopper..... | 25 | Round Disk Pads:..... | 46 |
| Clean Vac Box System..... | 26 | Cylindrical Brushes:..... | 46 |
| Remove Disk Brushes..... | 27 | EDGE Pads and Screens:..... | 46 |
| Remove Cylindrical Brushes..... | 28 | EDGE Grip Face:..... | 47 |
| Remove EDGE Pads..... | 29 | v2 Squeegee Blade Kits..... | 47 |
| | | MACHINE DECALS..... | 48 |



SAFETY MESSAGES

You will see four kinds of safety reminders in this manual:

DANGER

DANGER indicates a hazardous situation which, if not avoided, will result in death or serious injury.

CAUTION

CAUTION indicates a potentially hazardous situation which, if not avoided, could result in minor or moderate injury or damage to this machine or nearby objects. CAUTION also can be used to alert against unsafe practices.

WARNING

WARNING indicates a potentially hazardous situation which, if not avoided, could result in death or serious injury.

NOTICE

NOTICE indicates information considered important, but not hazard-related. This safety message may be related to property damage or warranty warnings.

Your safety, and that of others, is very important. Operating this machine safely is an important responsibility.

DO NOT OPERATE THIS MACHINE:

- Unless you are trained and authorized to do so by your RPS Authorized Local Distributor
- Unless you have read and understood this Operator's Manual
- On surfaces with greater than a 2% grade unless this machine is equipped with a functional parking brake
- On surfaces with greater than an 8% grade at any time
- On Loading Docks

WHEN OPERATING THIS MACHINE:

- Remove loose objects from the floor that could be projected from the rotating Brushes
- Keep your hands and feet away from the rotating Brushes
- Do not operate this machine where flammable liquids, vapors, or dust are present
- Use caution when maneuvering

BEFORE LEAVING THE MACHINE:

- Drain "clean" Solution & "dirty" Recovery solution into APPROVED drains
- Park the machine on a level surface
- Turn the machine off & remove key

BEFORE SERVICING THE MACHINE:

- Disconnect the Batteries
- Drain both tanks

DANGER

Explosive hydrogen gas forms when Batteries are charging. An open flame or spark can cause this gas to explode. Serious personal injury or property damage could occur. Only charge the Batteries in this machine in a well ventilated area.

DANGER

Flammable materials can cause an explosion or fire. Do not use flammable materials in Tank or pick up.

! WARNING

The Batteries in this machine produce hazardous voltage which can cause electrical shock, burns and/or electrocution. Always disconnect Batteries before servicing this machine.

! WARNING

When climbing or descending ramps, always drive machine forward. To avoid overturning the machine, Do not back down ramps. Do not drive across inclines. Do not turn while ascending or descending ramps. Overturning the machine can cause serious injury or death.

! WARNING

Do not use water that exceeds 135°F / 57°C. If water is above said temperature, this will void the Tank Warranty.

! WARNING

Do not park this machine on ramps or slopes. Always park this machine on a level, hard surface. Do not operate this machine outdoors or on uneven surfaces.

! WARNING

The Batteries in this machine contain sulfuric acid, which causes burns to skin. If battery acid contacts clothing or skin, rinse the effected area with cold water immediately. If battery acid gets on your face or in your eyes, flush the area immediately with cold water and seek medical attention.

! WARNING

To avoid electrical shock, do not operate this machine over electrical floor outlets.

! CAUTION

To avoid damage to this machine, use only cleaning solutions and replacement parts recommended by the manufacturer.

! CAUTION

Do not operate this machine if any parts have been damaged or removed.

! WARNING

Dress safely. Do not wear rings or metal wrist watches when servicing this machine, as they can cause an electrical short circuit which can cause serious burns.

! WARNING

Do not remove, paint over or destroy warning decals. If warning decals become damaged, call 1-262-681-3583 for free replacements.

! WARNING

Dress safely. Do not wear a neck tie, scarf, or any loose or dangling clothing while operating this machine. Loose or dangling clothing or neck-wear can tangle in rotating parts, causing serious injury or death.

! WARNING

Always turn off this machine before leaving it unattended. Do not allow untrained persons to operate this machine.

! WARNING

NO RIDERS. Do not carry passengers on this machine. Do not use this machine as a stepladder or work platform.

! WARNING

Understand the dynamic braking system before you operate the machine on ramps. Machine may coast.

! WARNING

Before you service a Battery, always wear face protection, protective gloves and protective clothing. Battery acid or battery explosion can cause serious injuries.

! CAUTION

Always use the automatic battery charger provided by the manufacturer of this machine to charge the Batteries of this machine. It is designed to charge the Batteries at the appropriate rate. If you must use a different charger, disconnect the Batteries before charging to avoid damage to the electronic speed controller.

! CAUTION

To avoid damage to the electronic control components of this machine, Do not store this machine outdoors. Do not pressure wash this machine.



SAFETY LABELS

Read and obey all Safety Labels on your Floor Scrubber. If you have questions about these labels, ask your supervisor. These images indicate where on the Floor Scrubber the Safety Labels are located. If ever the labels become illegible, worn off, or torn, promptly report it to your supervisor and replace it.

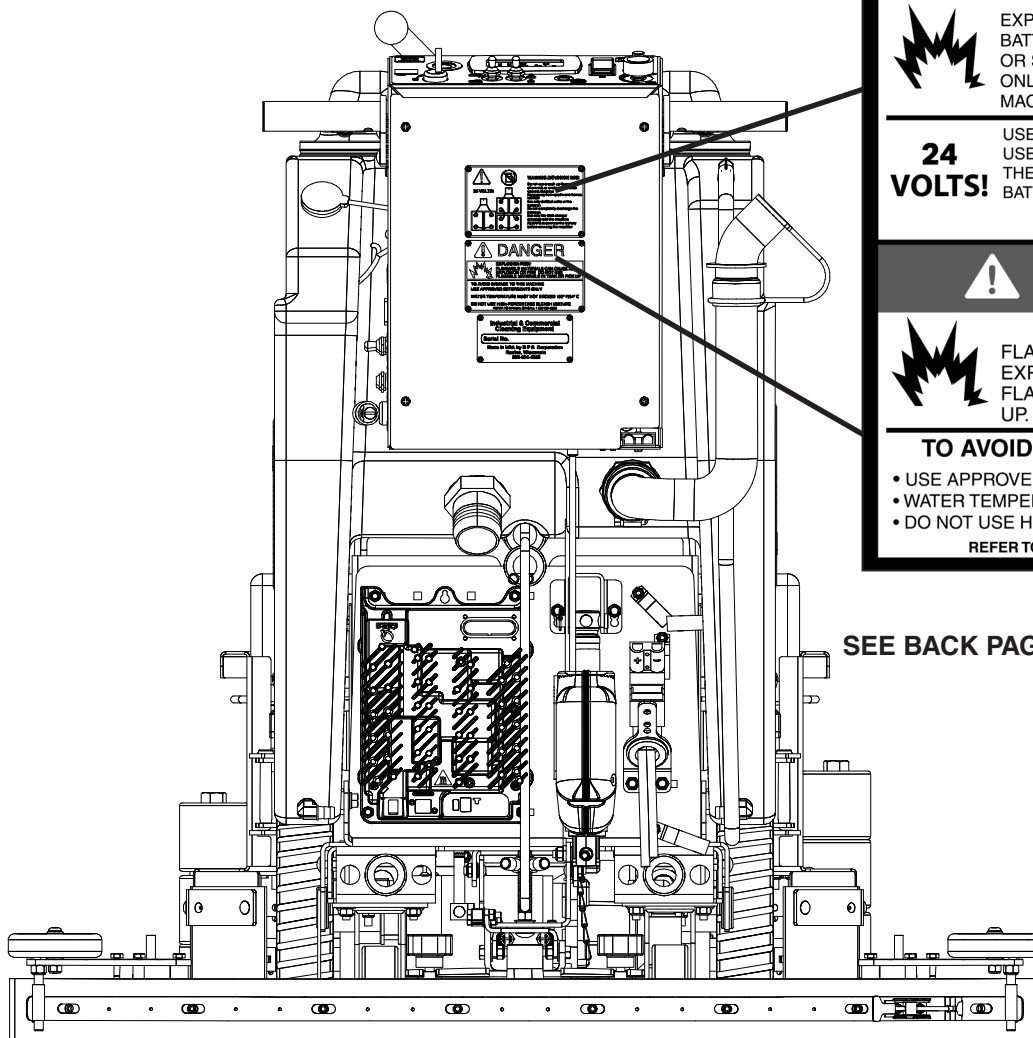

⚠ DANGER

EXPLOSION RISK!

EXPLOSIVE HYDROGEN GAS FORMS WHEN BATTERIES ARE CHARGING. AN OPEN FLAME OR SPARK CAN CAUSE THIS GAS TO EXPLODE. ONLY CHARGE THE BATTERIES IN THIS MACHINE IN A WELL VENTILATED AREA.

24 VOLTS!

USE ONLY DISTILLED WATER IN THE BATTERIES. USE ONLY THE OEM CHARGER PROVIDED WITH THE MACHINE. **ALWAYS** DISCONNECT THE BATTERY BEFORE SERVICING THE MACHINE.

REFER TO MANUAL OR CALL +001-262-681-3583

⚠ DANGER

EXPLOSION RISK!

FLAMMABLE MATERIALS CAN CAUSE AN EXPLOSION OR FIRE. DO NOT USE FLAMMABLE MATERIALS IN TANK OR PICK UP.

TO AVOID DAMAGE TO THIS MACHINE:

- USE APPROVED DETERGENTS ONLY
- WATER TEMPERATURE MUST NOT EXCEED 130°F/54°C
- DO NOT USE HIGH-PERCENTAGE BLEACH MIXTURE

REFER TO MANUAL OR CALL +001-262-681-3583

SEE BACK PAGE FOR DECAL PART NUMBERS

CENTRAL COMMAND DASHBOARD CONTROLS (MILITARY, TOUCH SCREEN)

1. Squeegee Lever
2. Reverse Switch
3. Drive Switch (Both Handles)
4. E-Stop
5. Key Switch
6. Vac Clog Light
7. ZER03 Light
8. Speed Potentiometer
9. Vac Switch
10. Solution Switch
11. Scrubdeck Switch
12. Down pressure Switch
13. Military Flow Lever
14. Military Status Light
15. Military Battery Gauge / Hour Meter Combo
16. Military Down Pressure Gauge

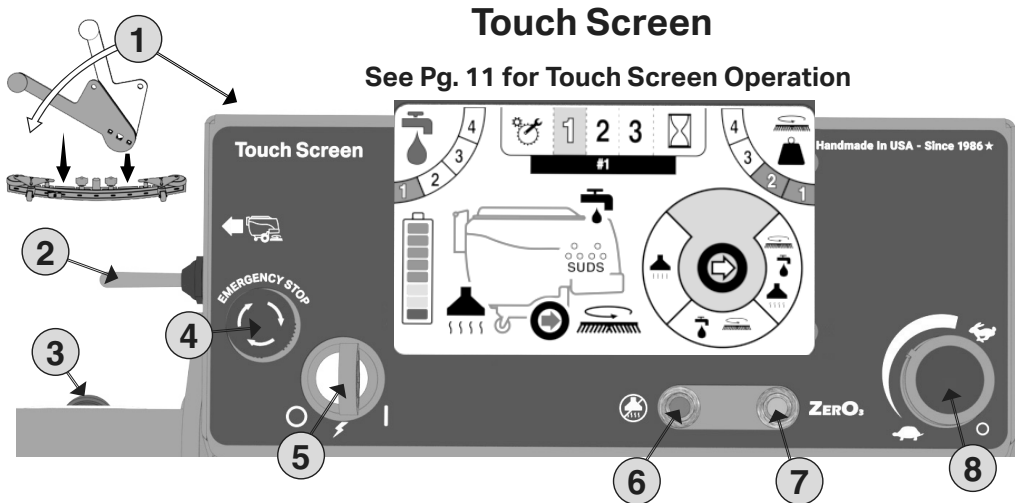
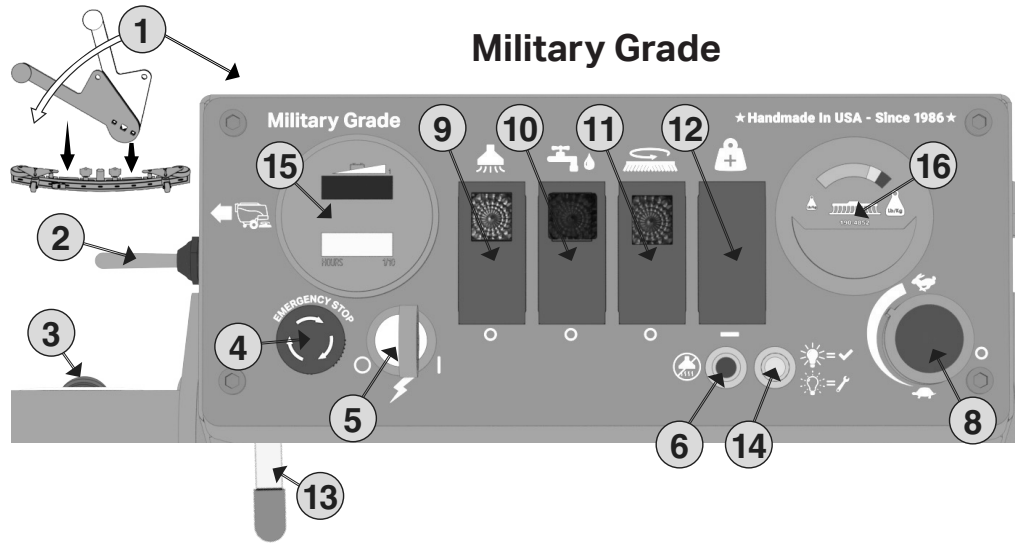

CENTRAL COMMAND SIDE PANEL CONTROLS

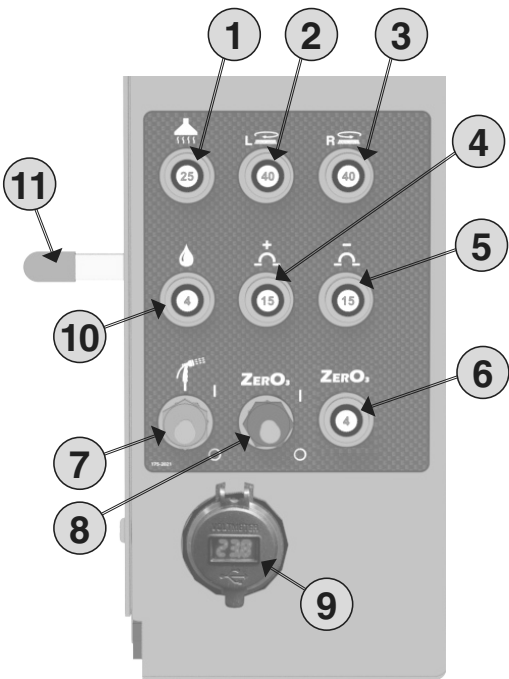

Military Grade

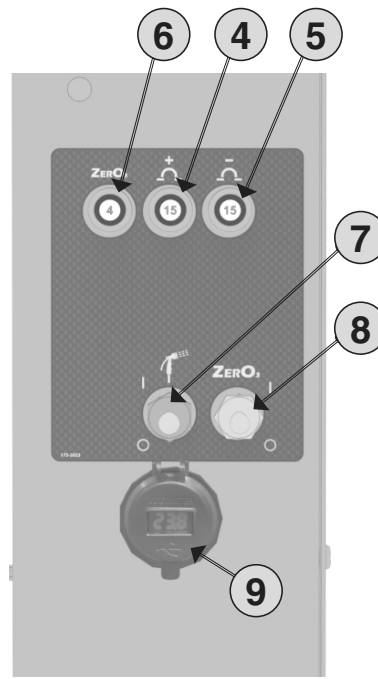
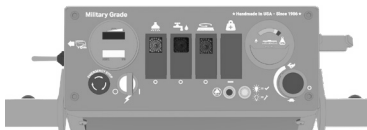

Touch Screen

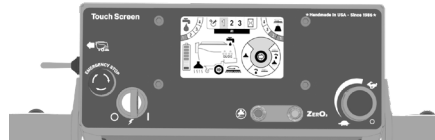

- | | | |
|----------------------------------|------------------------------------|-------------------------------------|
| 1. Vac Circuit Breaker | 6. ZER03 Circuit Breaker | 11. Military Solution Control Lever |
| 2. Left Brush Circuit Breaker | 7. Spray Jet On (I) / Off (O) | |
| 3. Right Brush Circuit Breaker | 8. ZER03 On (I) / Off (O) | |
| 4. Positive BUSS Circuit Breaker | 9. Dual USB Voltmeter | |
| 5. Negative BUSS Circuit Breaker | 10. Solution Valve Circuit Breaker | |

TOUCH SCREEN (OPTIONAL)

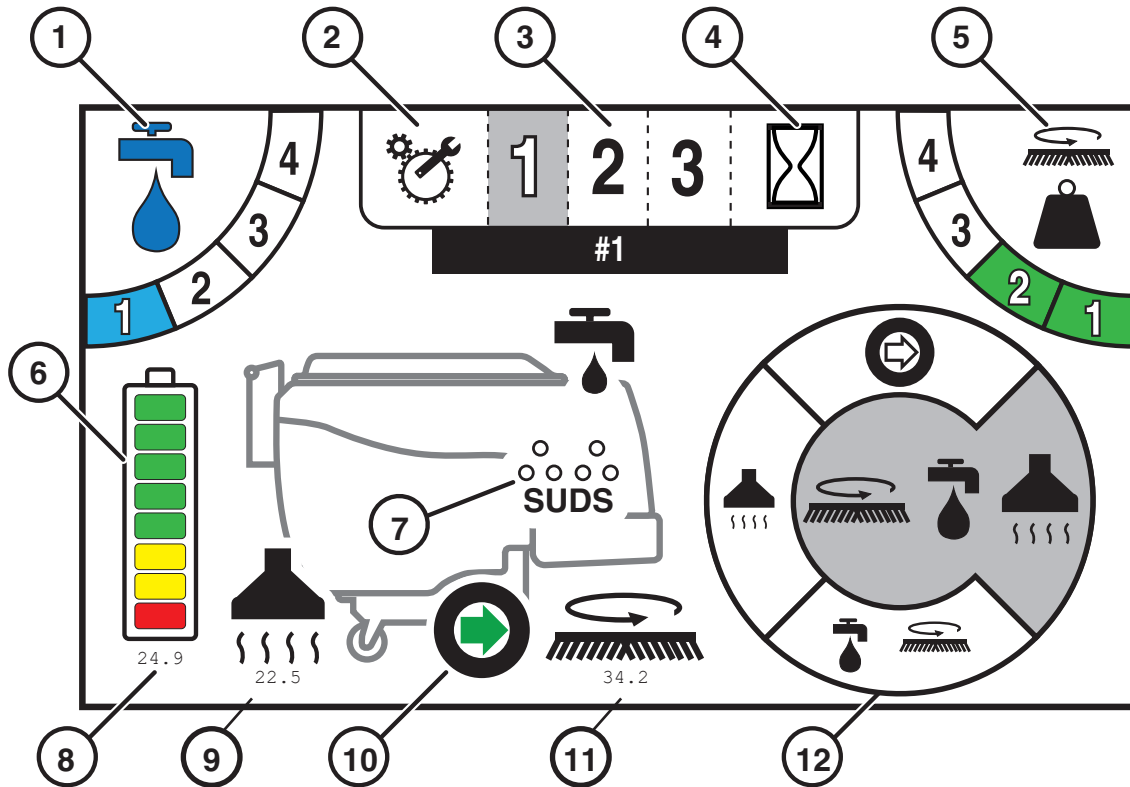
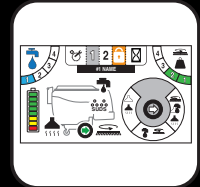

1. **SOLUTION OUTPUT** - Indicates the level of solution that is being dispensed when in operation, (0 = off, 1 = Low, 4 = High).
2. **TECHNICAL / MANAGER SETUP** - Access 'Error Code History' and Manager Programming
3. **PROGRAMMED ZONES** - Switch between preset solution and downpressure settings for varying applications
4. **HOUR METERS** - Displays all of the hour meters of the machine: Key Switch, Transport, Scrub Motors, and Vacuum Motor
5. **DOWN PRESSURE OUTPUT** - Indicates the level of downpressure that is being applied to the floor surface (1 = low, 4 = high).
6. **BATTERY GAUGE** - Indicates the level of battery charge available and volt meter
7. **SUDS** - (Onboard Chemical Dilution) indicator
8. **ACTIVE VOLT & AMP DRAW** - Indicates the live DC Volts (under battery gauge) and Amp draw (under systems) when machine is running
9. **AMP VAC CURRENT** - Indicates Vac power consumption
10. **TRANSPORT INDICATION** - Green Forward & Red Rev
11. **BRUSH DISK CURRENT** - Indicates Brush power consumption
12. **OPERATION MODE SELECTOR** - Cycle through and select which operation mode you would like to work in

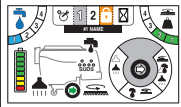

TOUCH SCREEN SYMBOLS (OPTIONAL)

Mode Selection

| Transport Only | Single Scrub | Double Scrub | Vacuum Only |
|----------------|--------------|--------------|-------------|
| | | | |

Solution Setting

| #0 | #1 | #2 | #3 | #4 |
|----|----|----|----|----|
| | | | | |

Down Pressure Setting

| #1 | #2 | #3 | #4 |
|----|----|----|----|
| | | | |

Forward Transport Motor

| Working | Active | Inactive |
|---------|--------|----------|
| | | |

Reverse Transport Motor

| Working | Active | Inactive |
|---------|--------|----------|
| | | |

Solution Flow

| Working | Active | Inactive |
|---------|--------|----------|
| | | |

Vacuum Motor

| Working | Active | Inactive |
|---------|--------|----------|
| | | |

Suds

| 250:1 Dilution | 125:1 Dilution | Inactive |
|----------------|----------------|----------|
| | | |

Scrub Deck Motor(s)

| Working | Active | Inactive |
|---------|--------|----------|
| | | |

Setup



Hour Meters



Zone Lock

| Locked | Unlocked |
|--------|----------|
| | |

TOUCH SCREEN ZONE OPERATION (OPTIONAL)

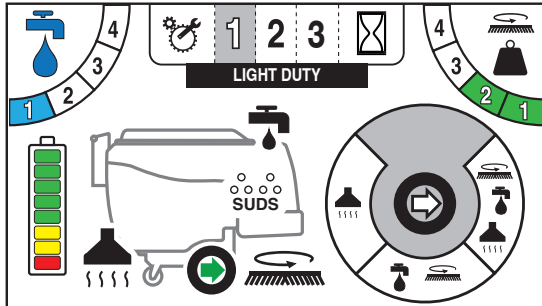

The touch screen is designed to be programmed to three specific zones. Each zone can be named and custom programmed or even disabled if not needed.

The zone you are working in is highlighted as indication. In Figure 1. the zone selected is Light Duty.

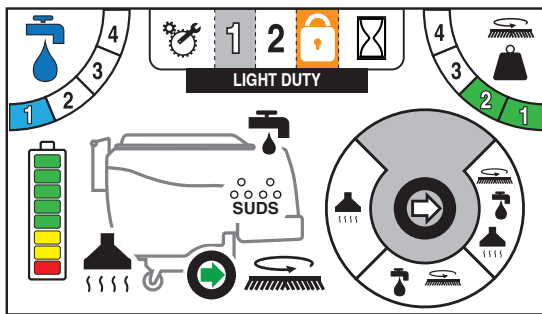

Figure 2. shows Zone 3 “locked out” by the indicator lock icon.

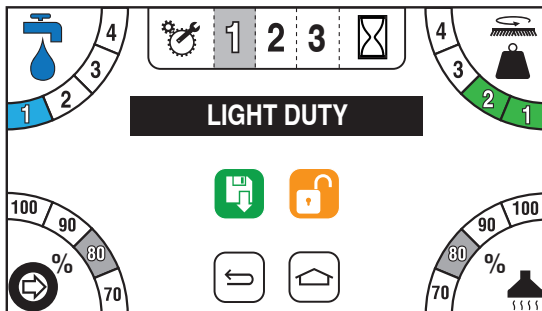

Figure 3. shows Zone 1 “Light Duty” Factory Configuration.

Water = 1
Downpressure = 2
Drive Speed = 70%
Vac Motor = 80%

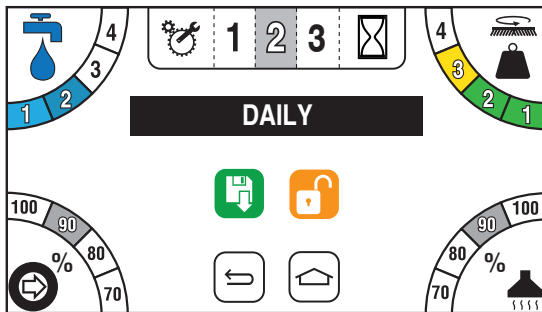

Figure 3. shows Zone 2 “Daily” Factory Configuration.

Water = 2
Downpressure = 3
Drive Speed = 90%
Vac Motor = 90%

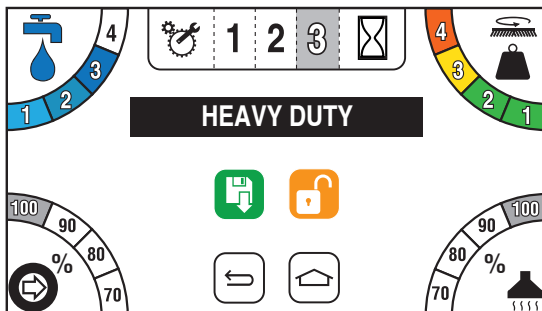
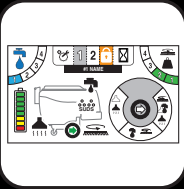
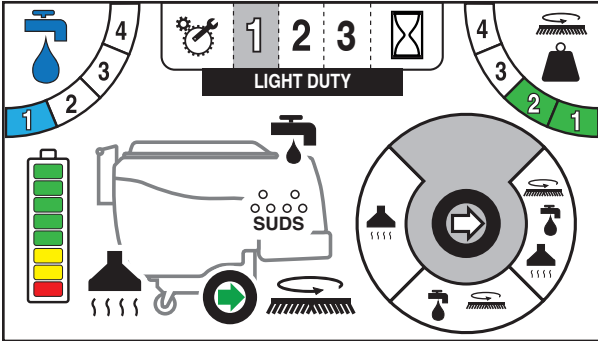

Figure 3. shows Zone 3 “Heavy Duty” Factory Configuration.

Water = 3
Downpressure = 4
Drive Speed = 100%
Vac Motor = 100%



TOUCH SCREEN ZONE PROGRAMMING (OPTIONAL)



To program the 3 Zones, press

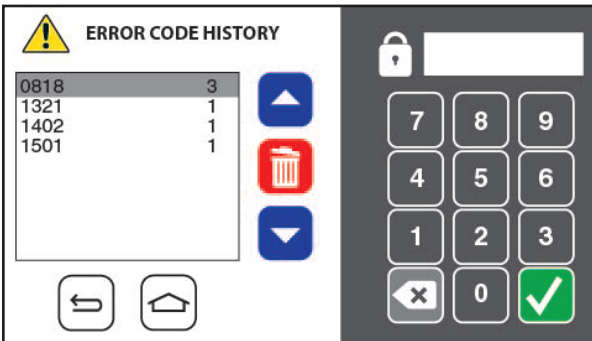

From here you will be prompted with a passcode screen. Enter the manager passcode 349 to get access to setup.



Once you have entered the password, you will see the Figure 3. screen where you can alter the name, solution output, down-pressure setting, scrubbing speed, and vacuum power.

Alternatively you can lock the Zone out from this screen, to prohibit operator use.

Once any of the 3 “Zones” is locked the remaining zones are no longer adjustable either by the operator.



To alter the name of a Zone, simply click on the black name box and a full keyboard will appear as Figure 4. shows. Enter new name and save your work with the Green save icon. 

BATTERY SETUP

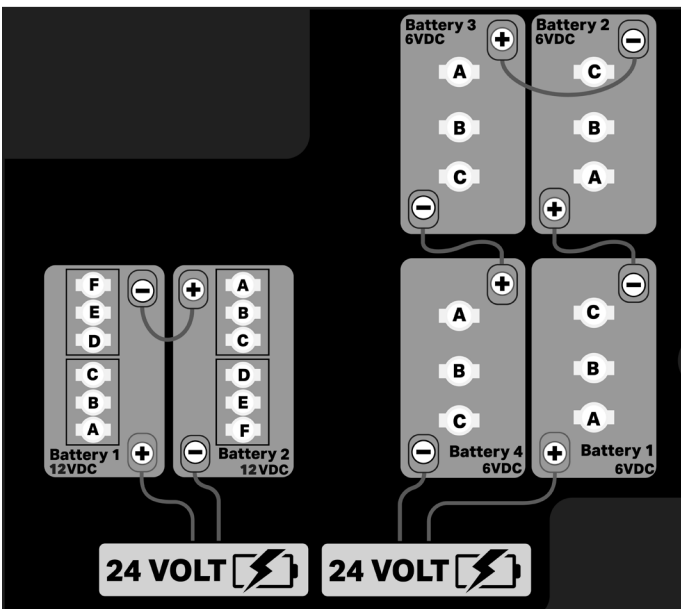
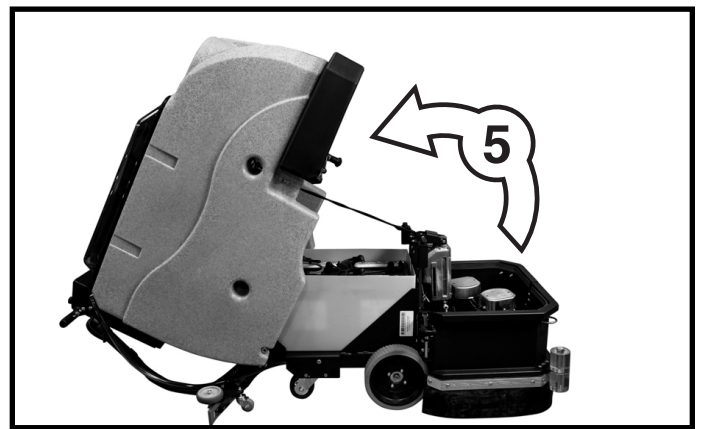
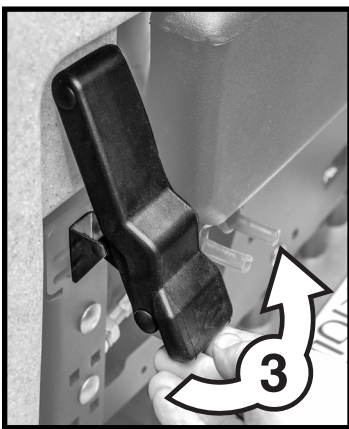
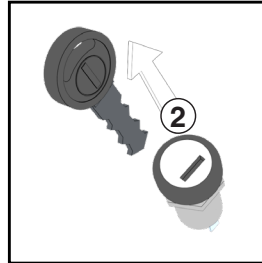
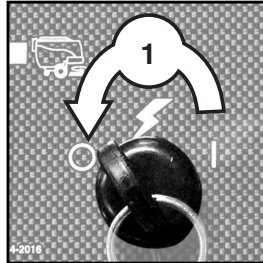
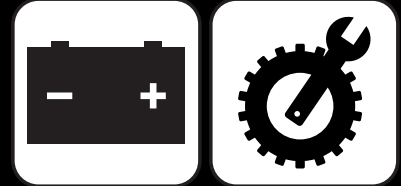

NOTICE
Batteries are a possible environmental hazard. Consult your Battery supplier for safe disposal methods.

NOTICE
Orientation of Batteries is critical for cables to reach. Ensure proper torque values when installing batteries. (Between 8 - 12 ft/lbs)



INSTALL SQUEEGEE

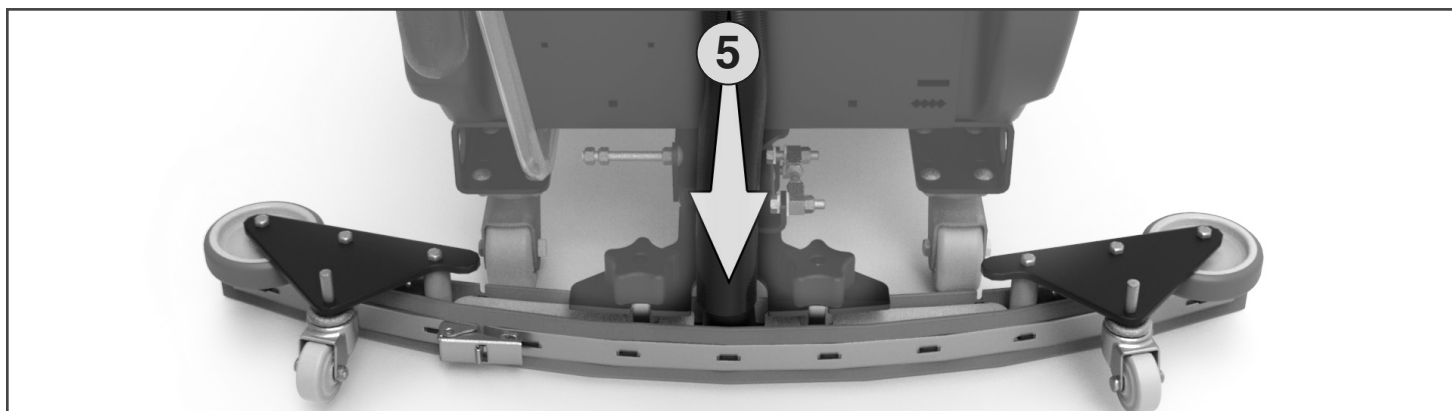
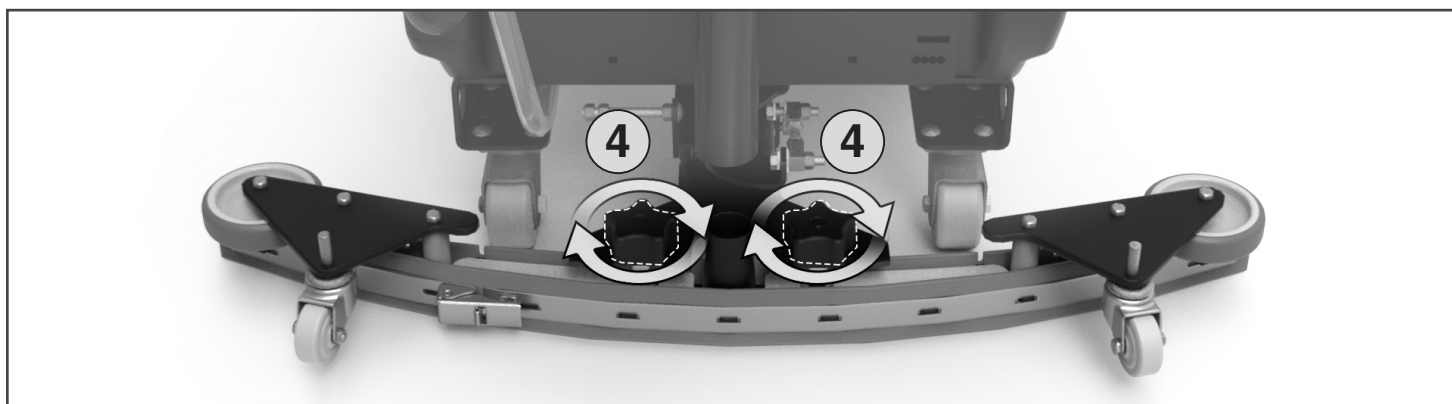
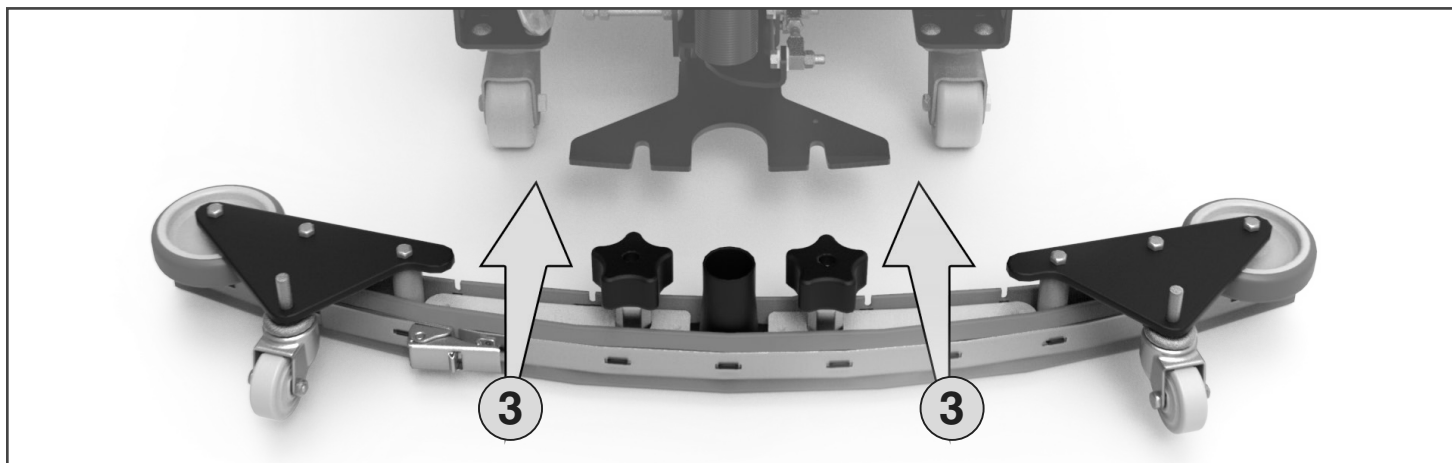
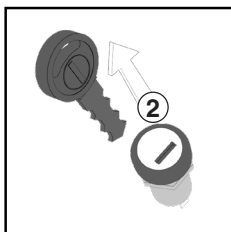
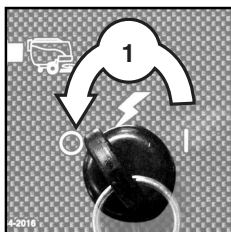

ADJUST SQUEEGEE

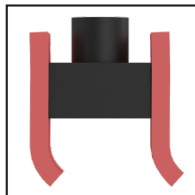
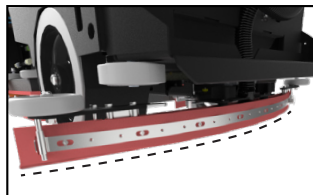
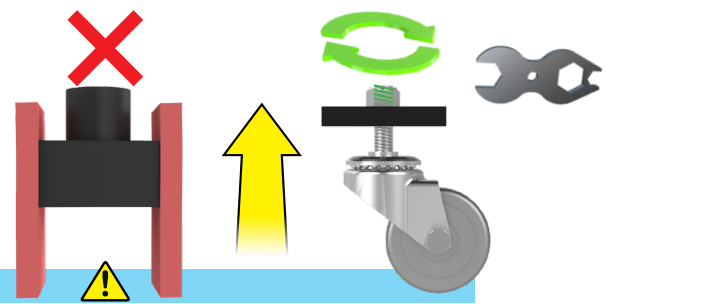
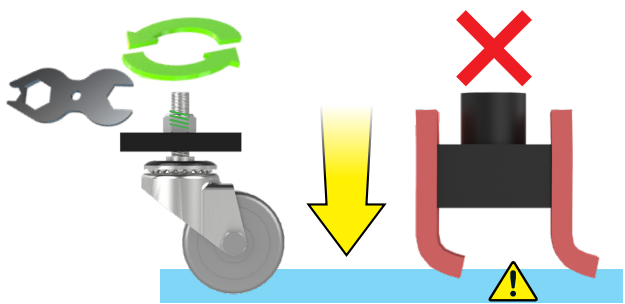
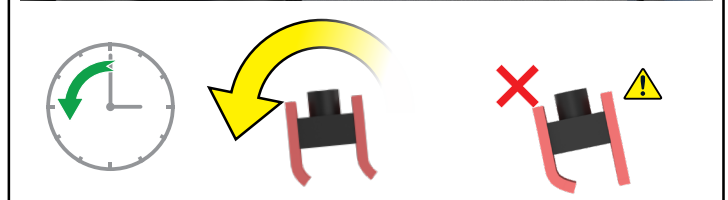
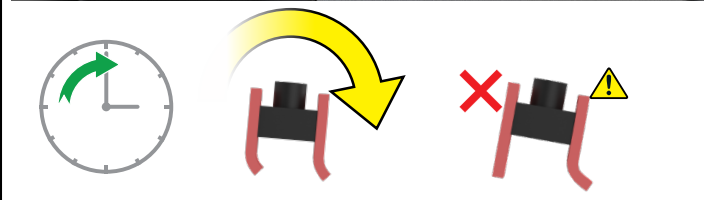
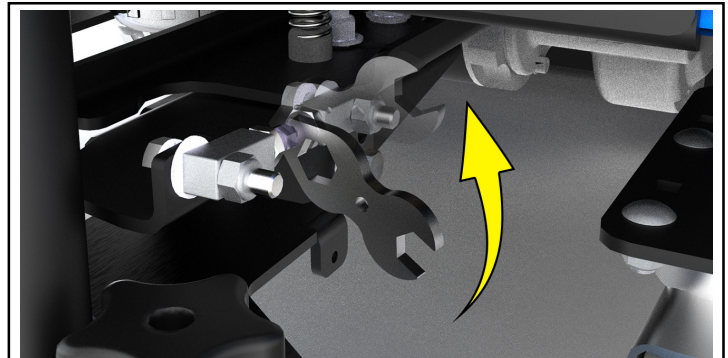
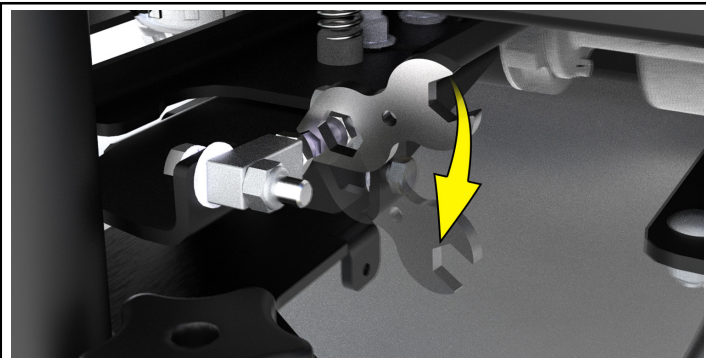
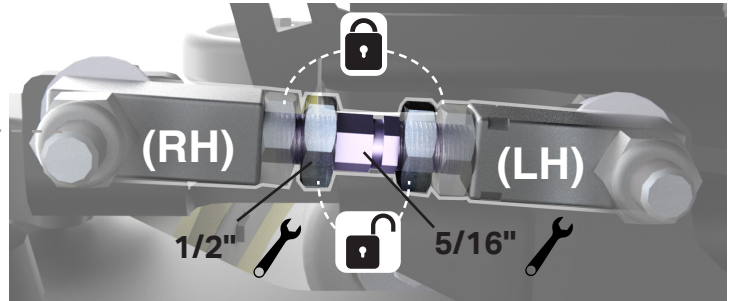
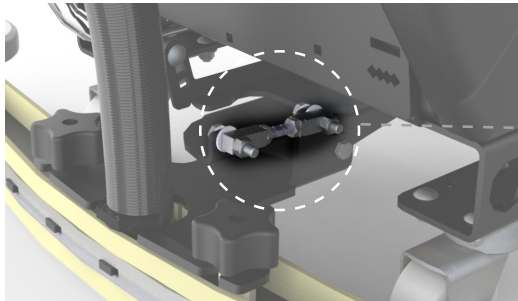
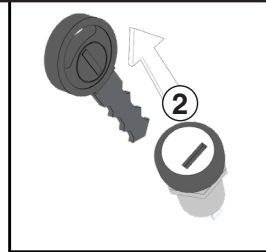
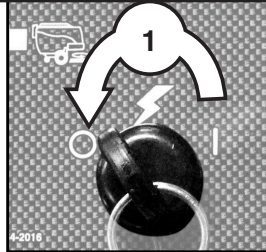
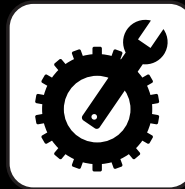

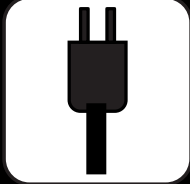
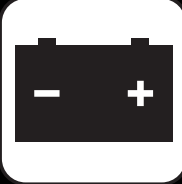

REMOVE FROM BATTERY CHARGER

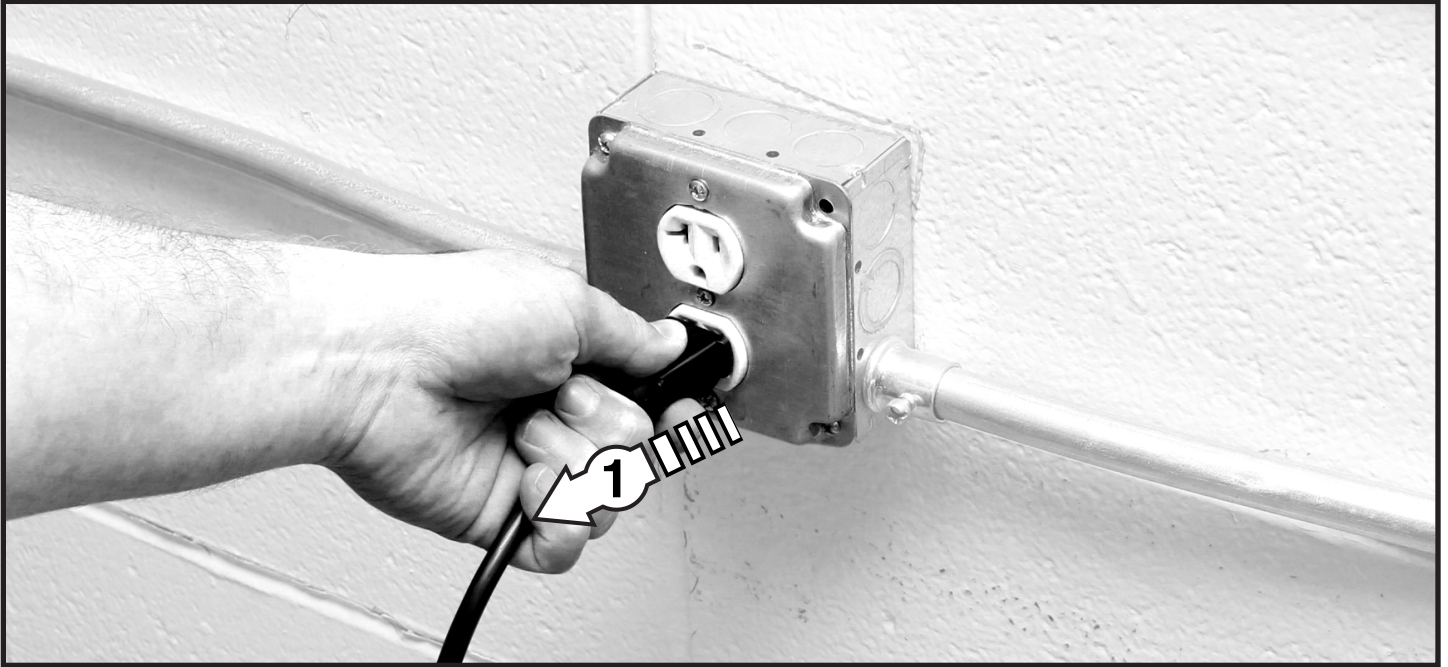

Please refer to OEM Charger Operating Instructions for more information.

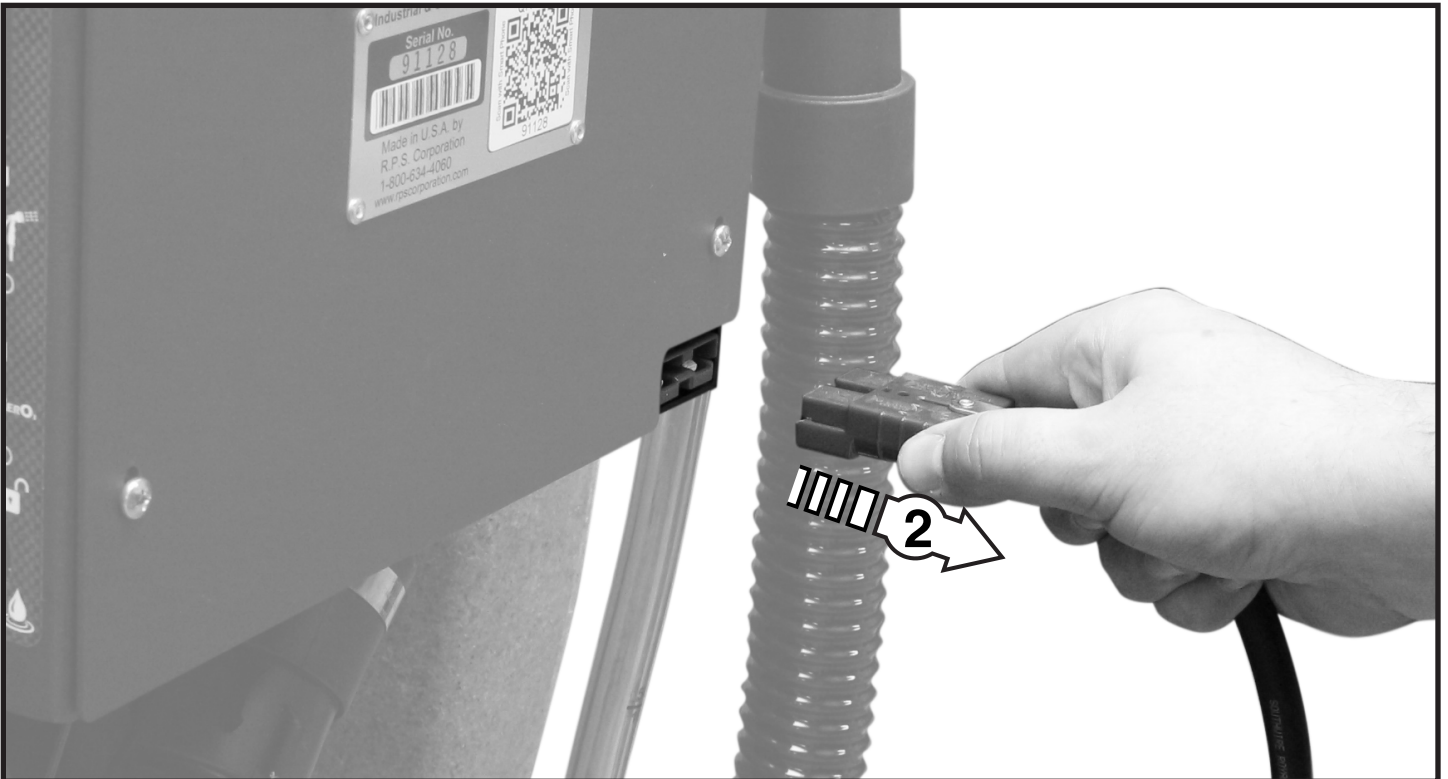

TRANSPORTATION - FORWARD



Military Grade

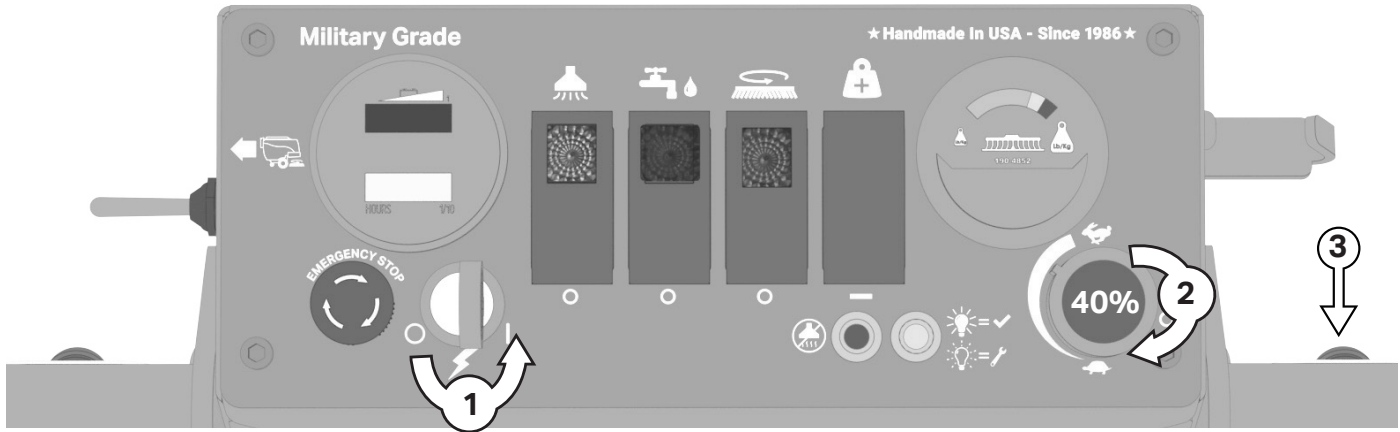

Touch Screen

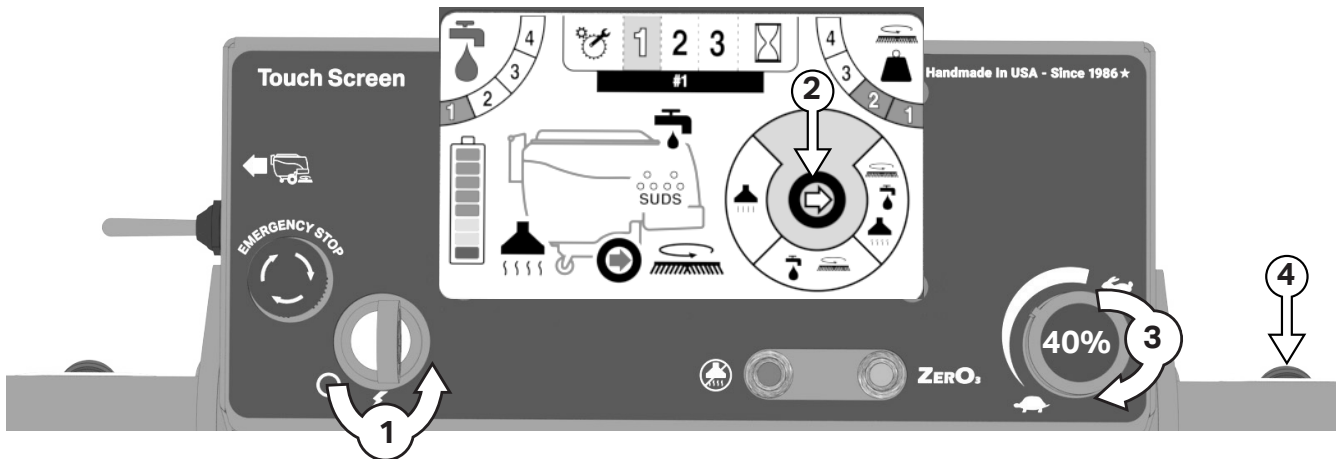



TRANSPORTATION - REVERSE

Military Grade

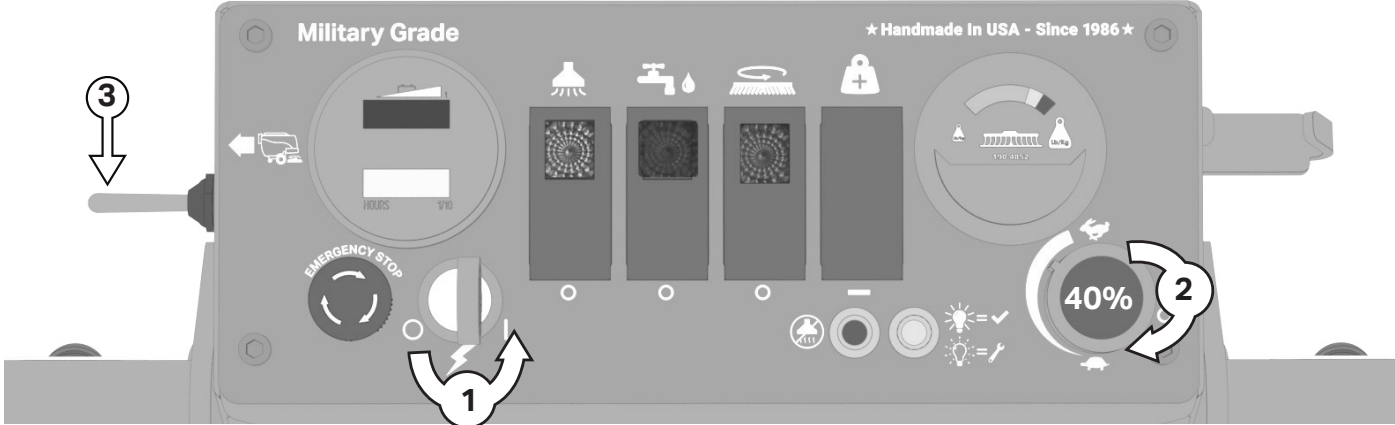

Touch Screen

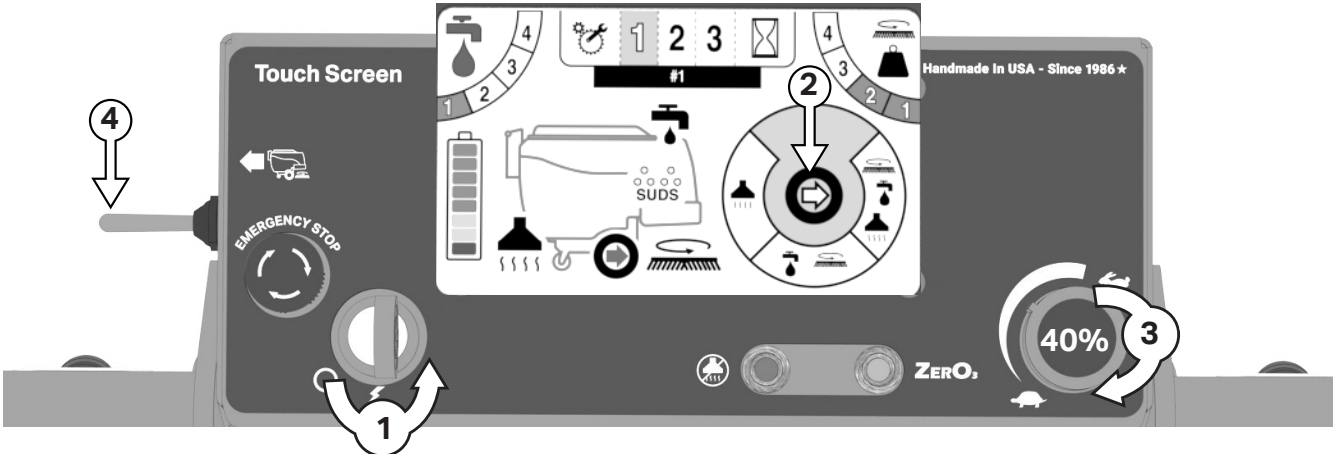

FILL SOLUTION TANK

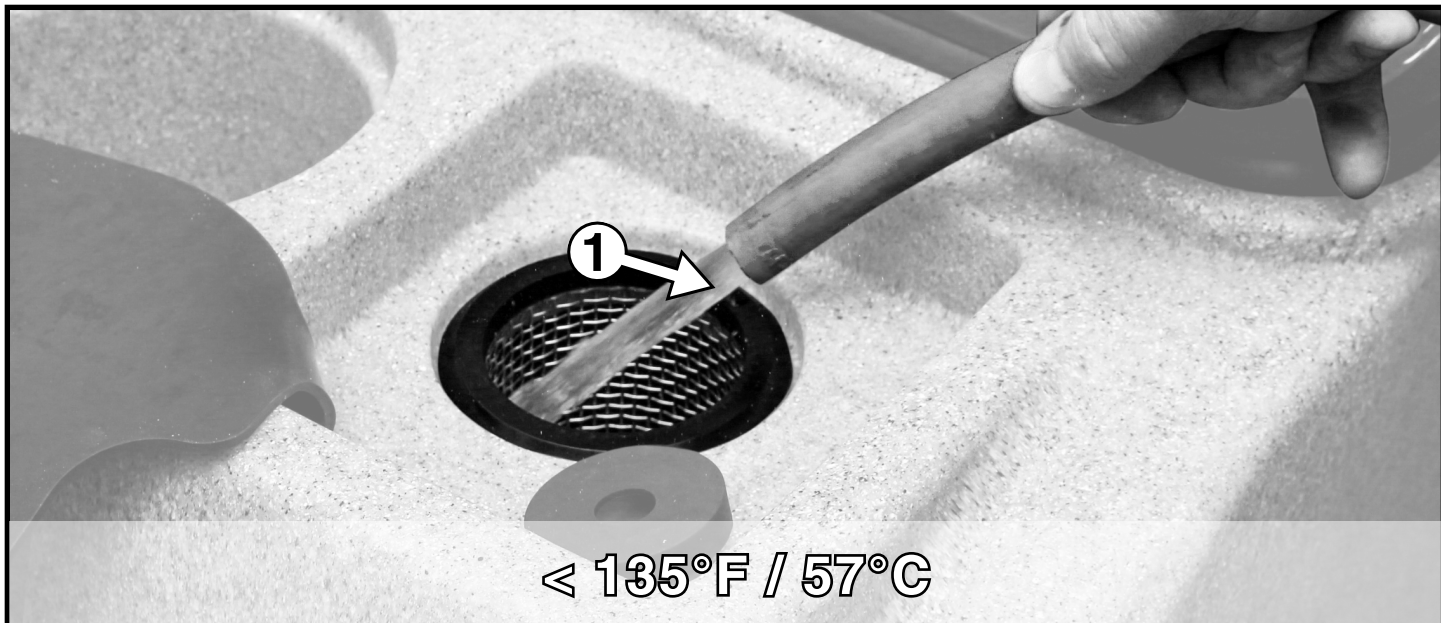

⚠ DANGER

EXPLOSION RISK! Flammable materials can cause an explosion or fire. Do NOT use flammable materials in Tank or pick up.

⚠ CAUTION

TO AVOID DAMAGE TO THIS MACHINE:

- Use APPROVED detergents only
- Water temperature must not exceed 135°F/57°C
- Do NOT use high-percentage Bleach mixture

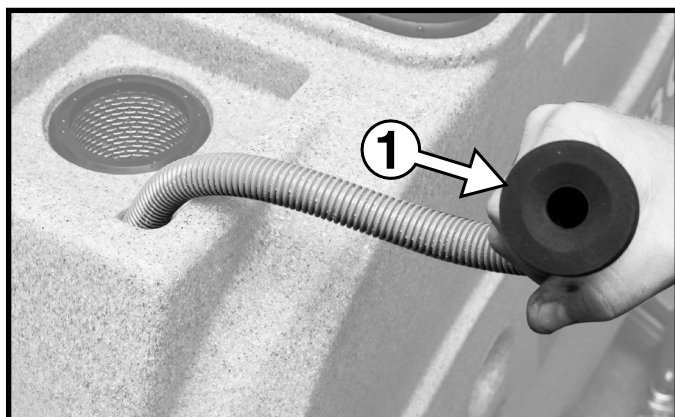



OPERATION - SCRUBBING

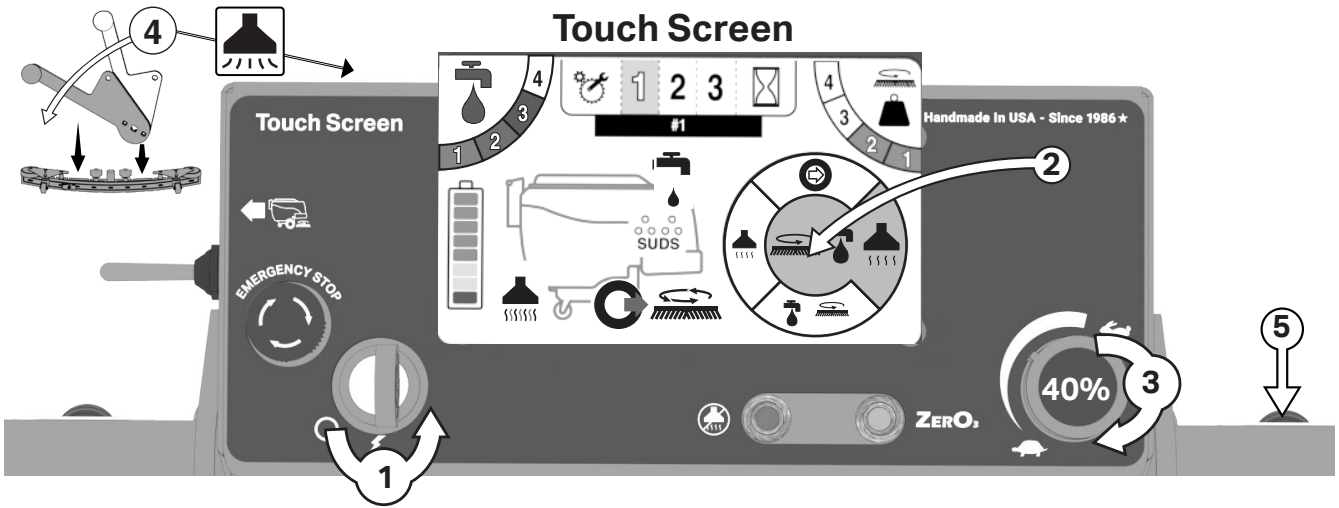
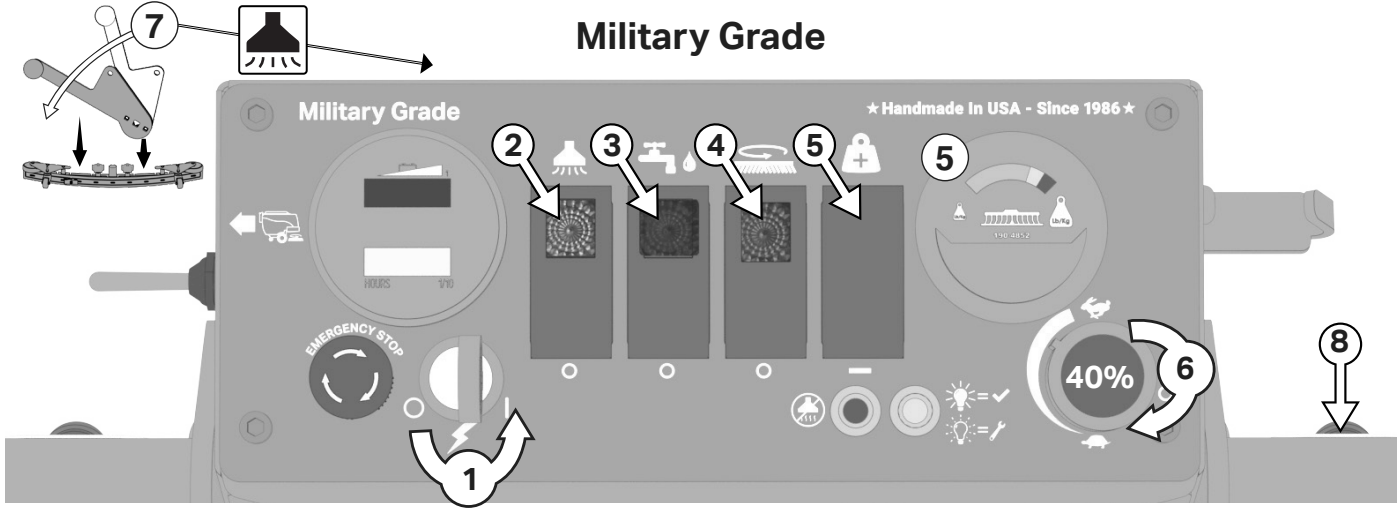

DRAINING RECOVERY TANK

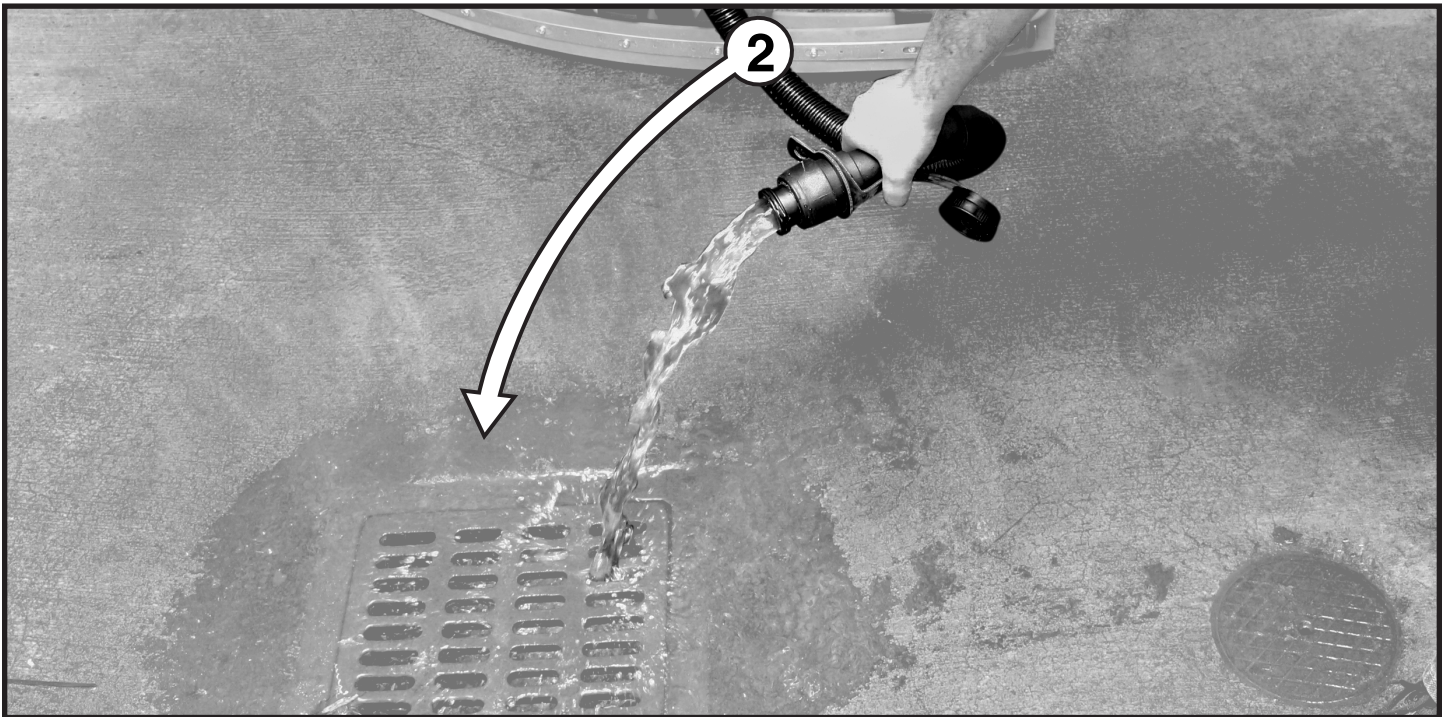
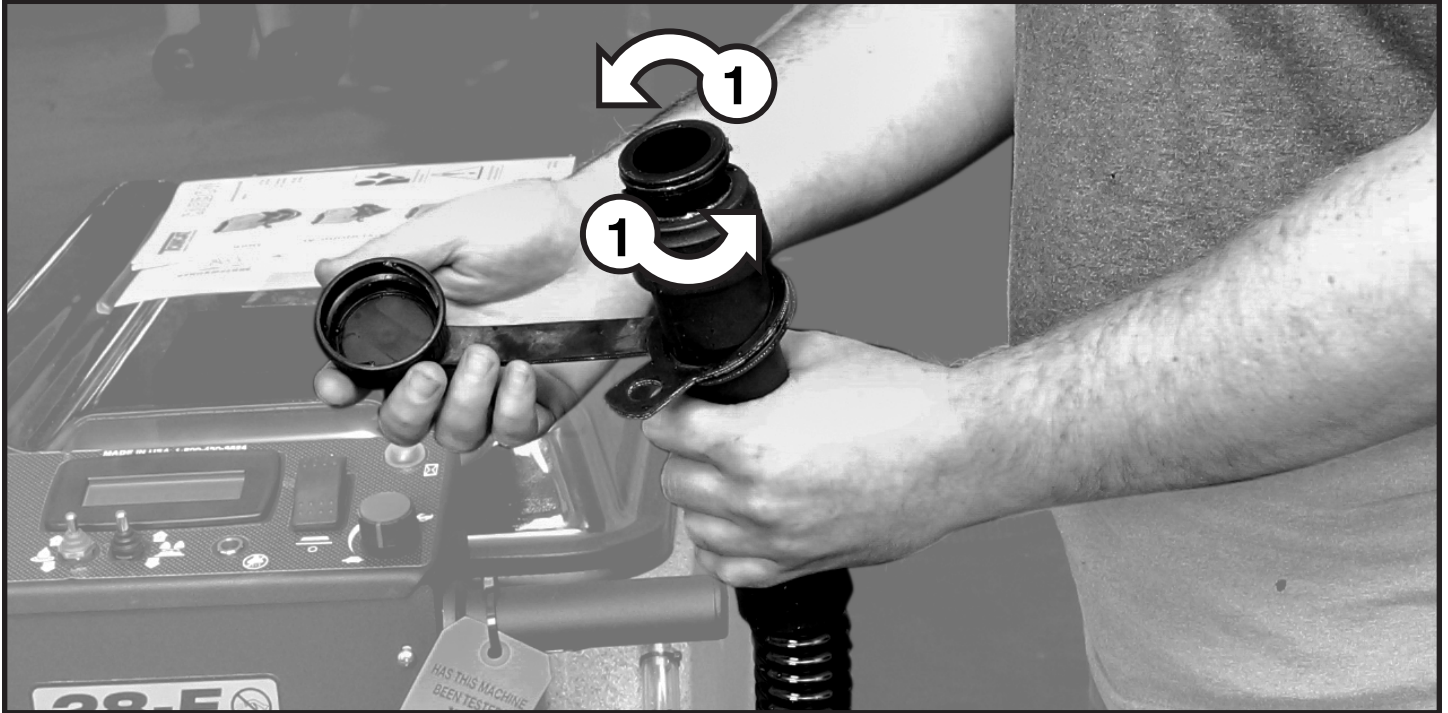
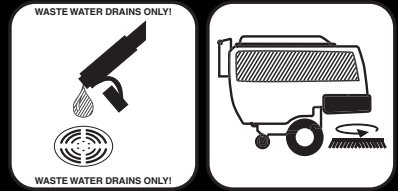



DRAINING SOLUTION TANK

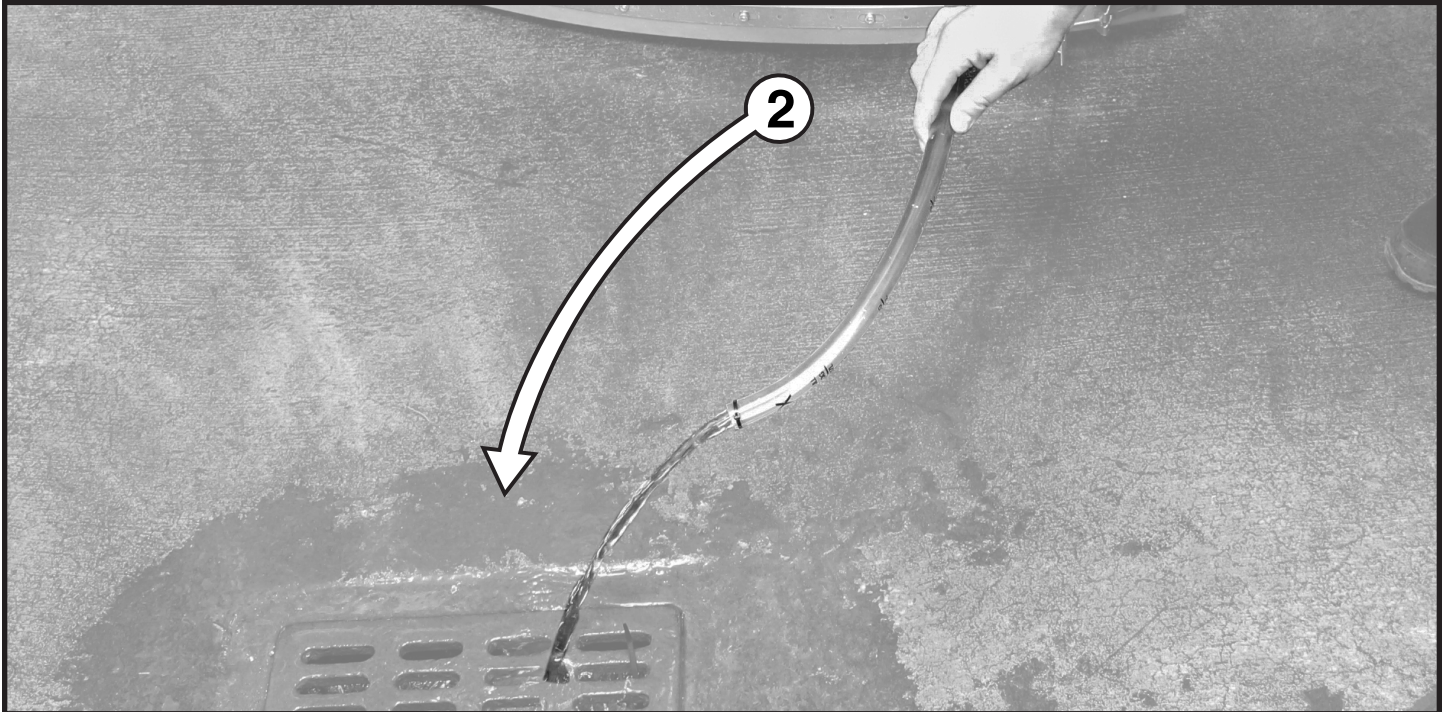
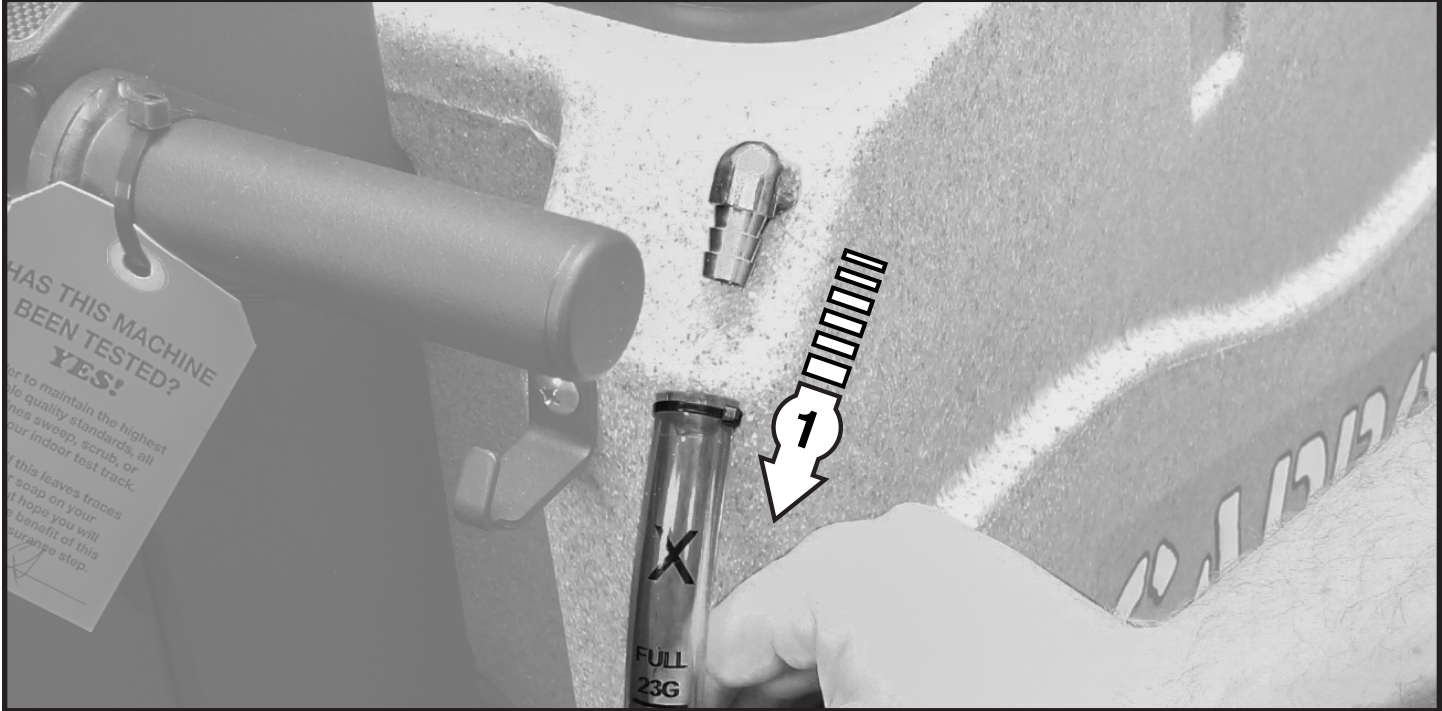

FLUSHING RECOVERY TANK

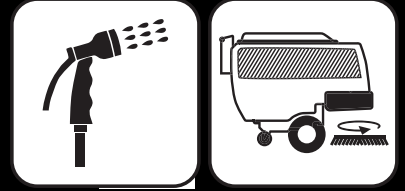



CLEAN DRAIN SAVER

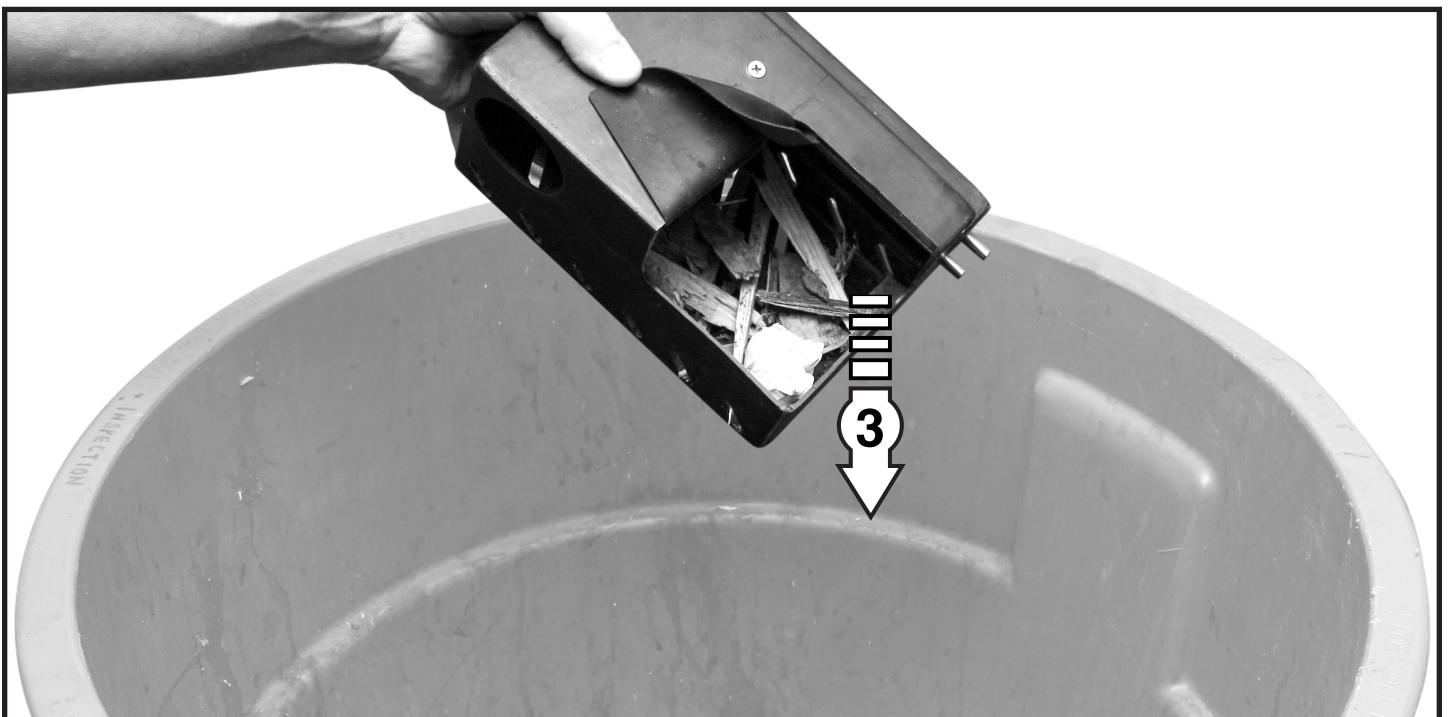
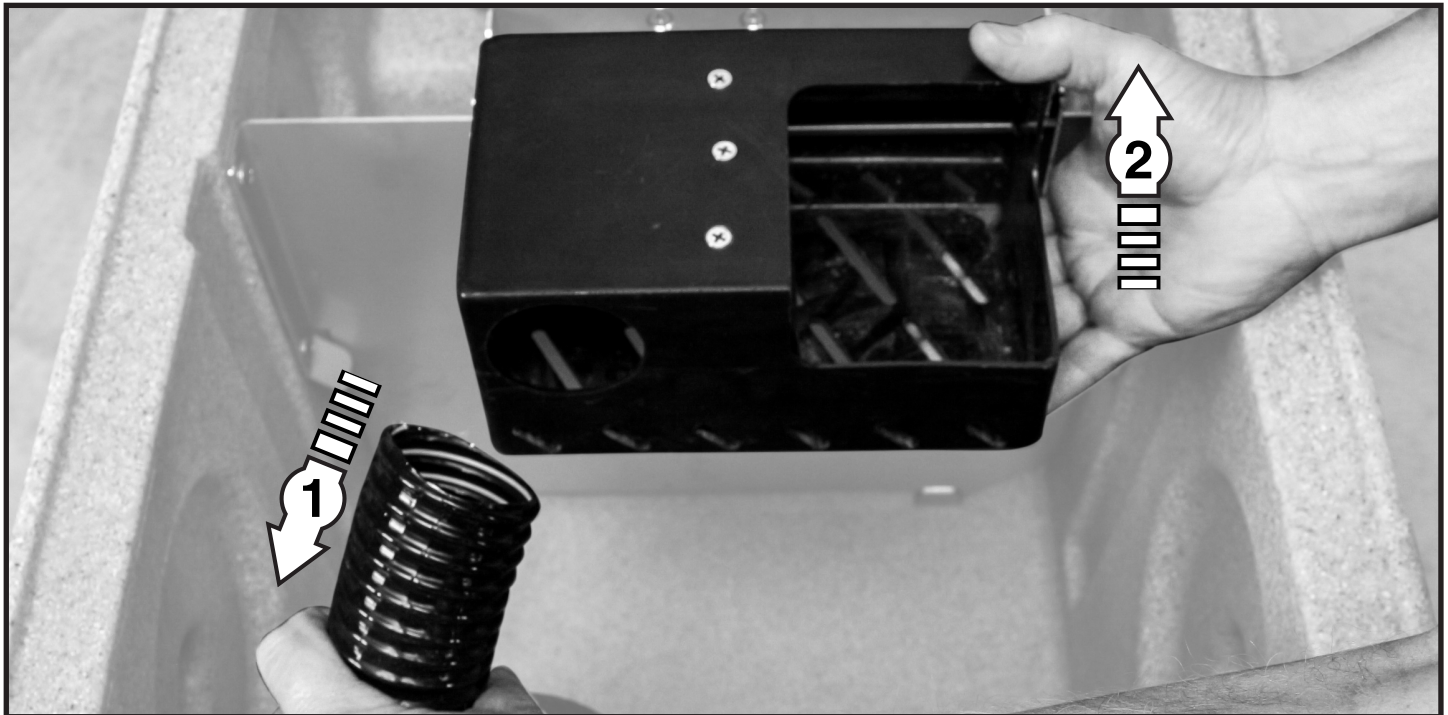

CLEAN CYLINDRICAL HOPPER

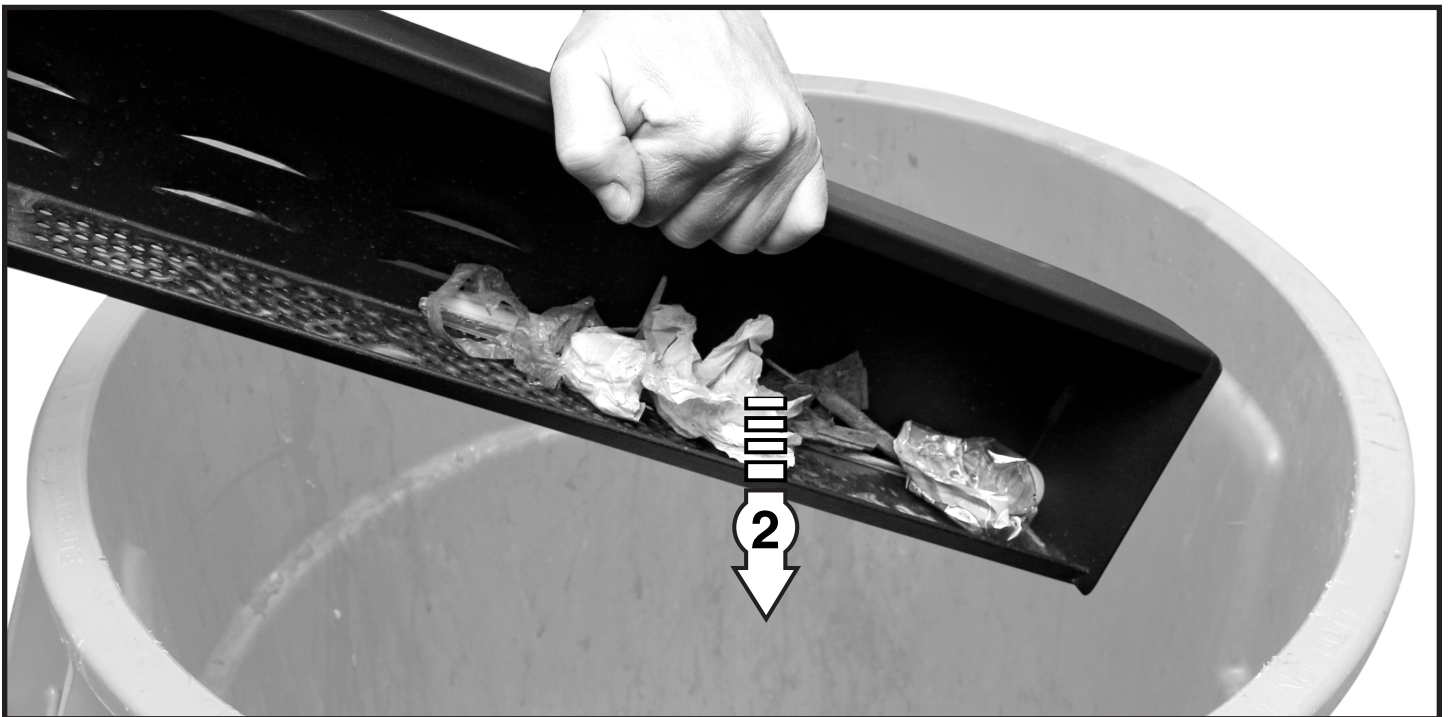
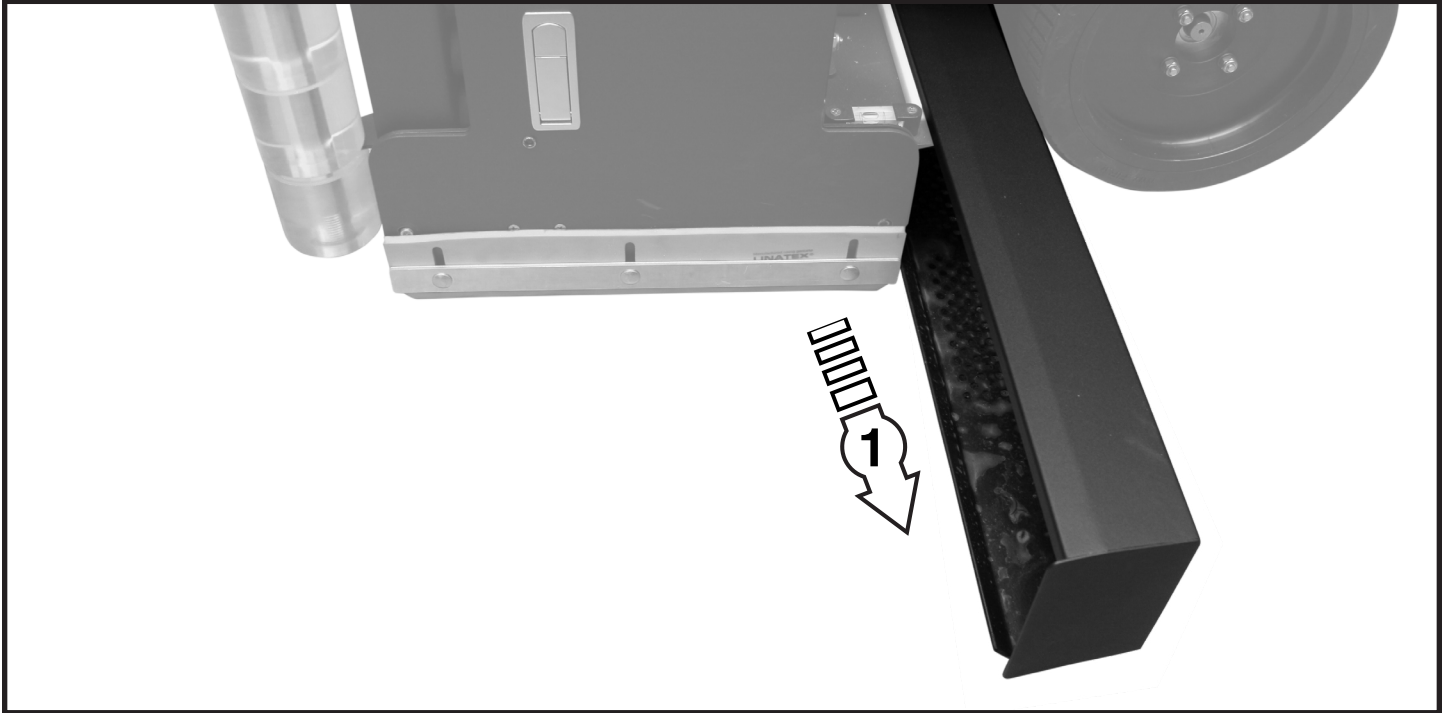

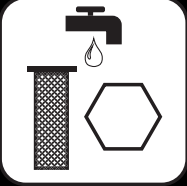

CLEAN VAC BOX SYSTEM

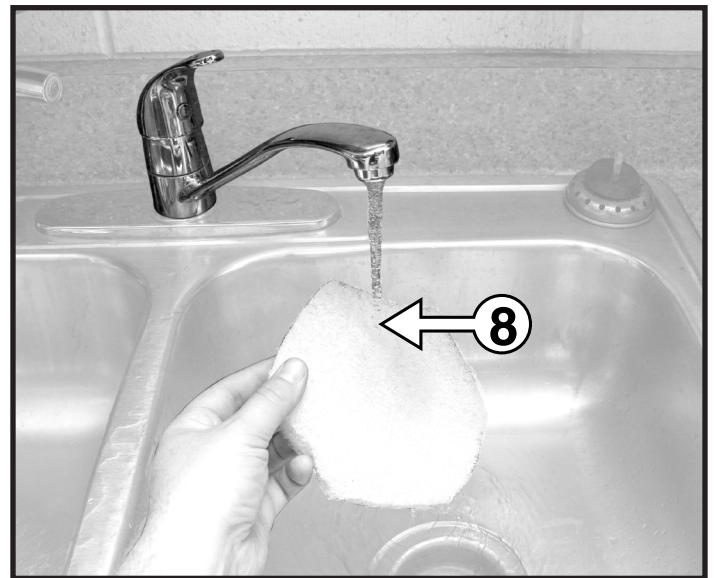
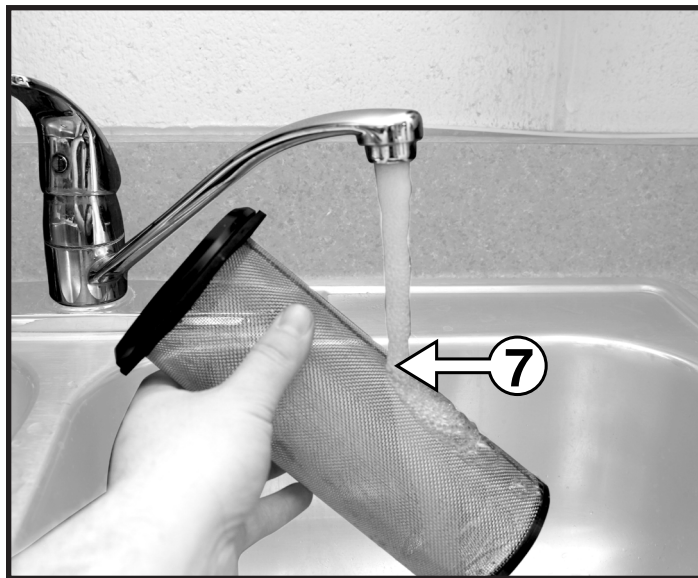
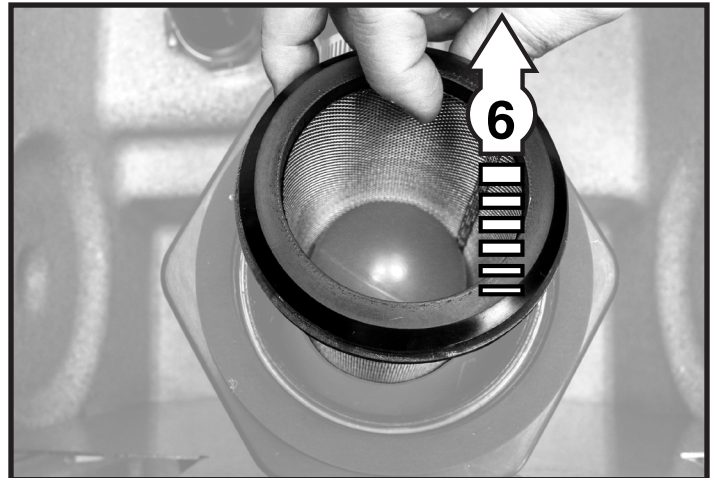
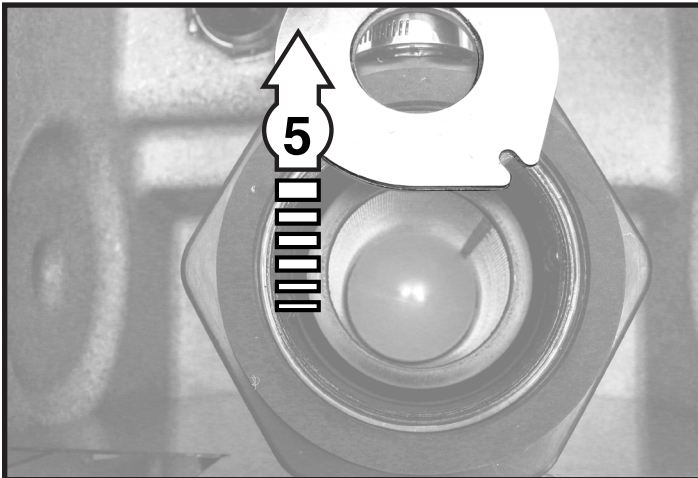
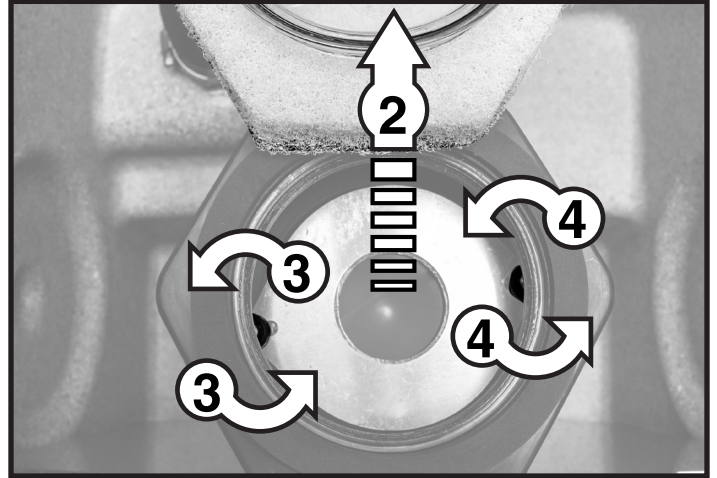
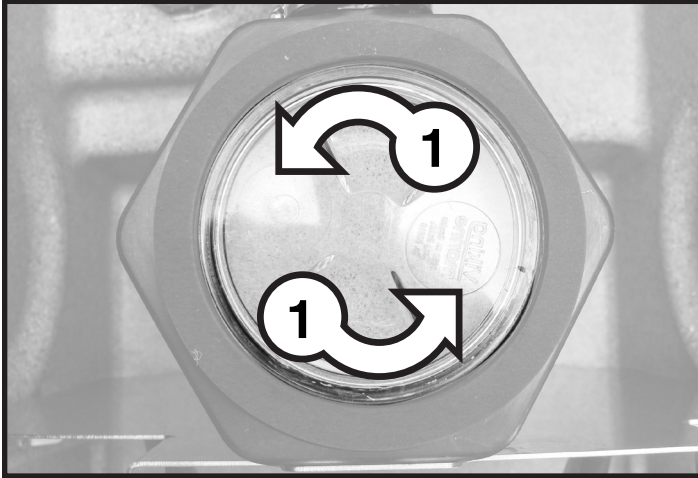

REMOVE DISK BRUSHES

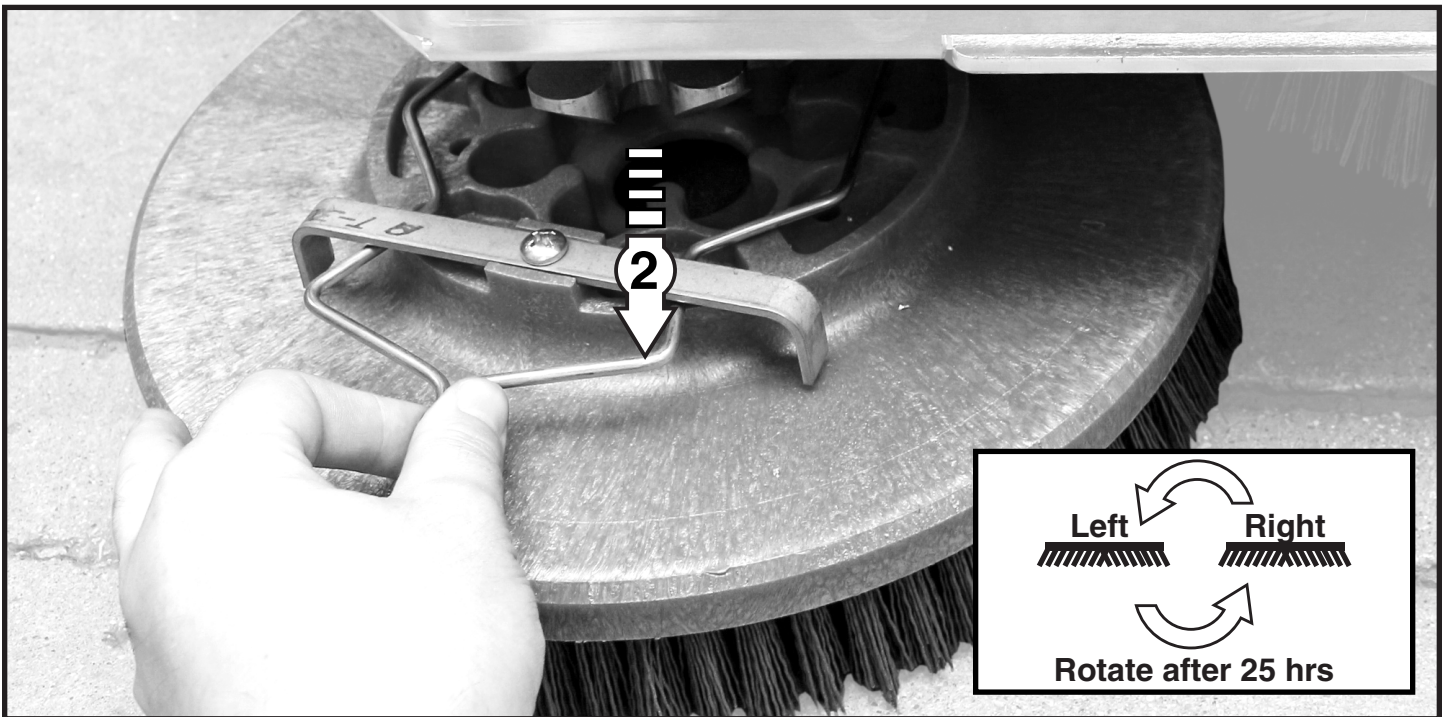

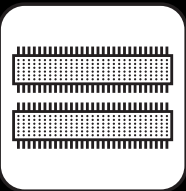

REMOVE CYLINDRICAL BRUSHES

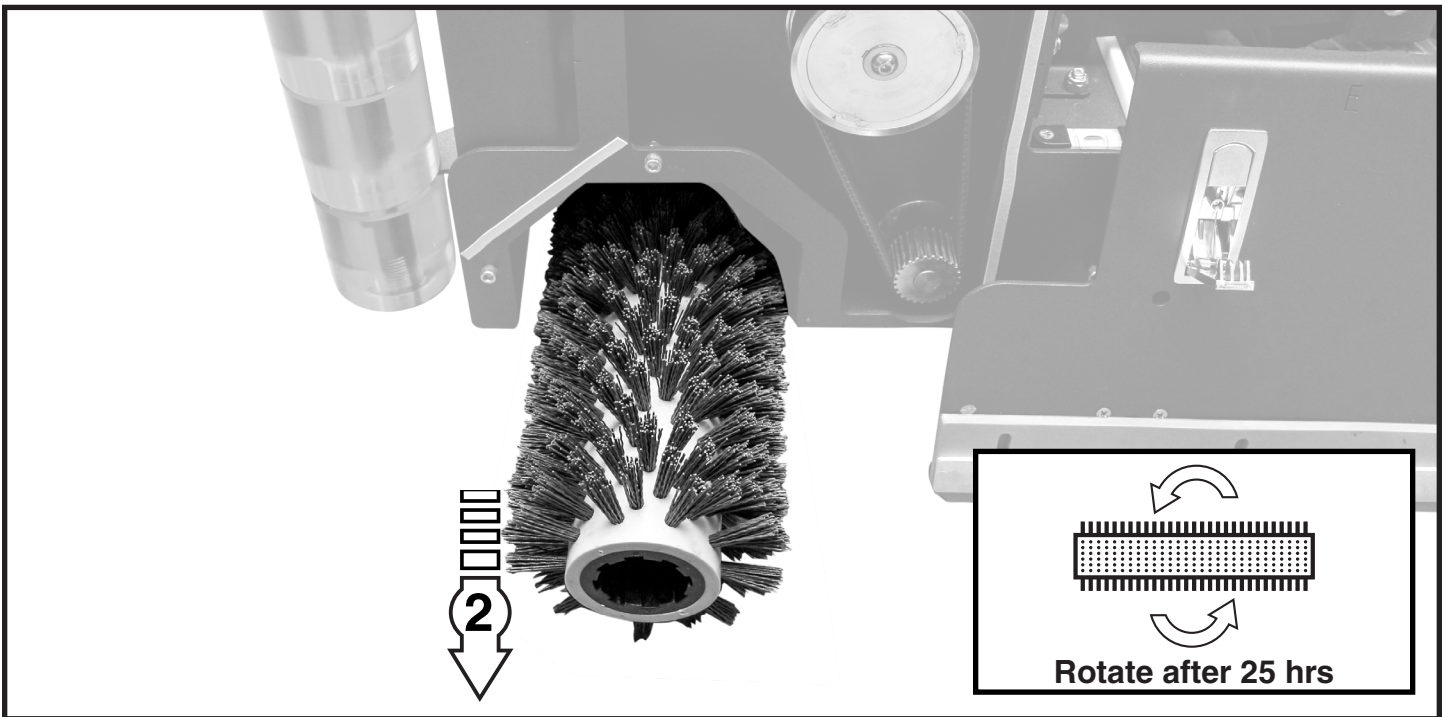
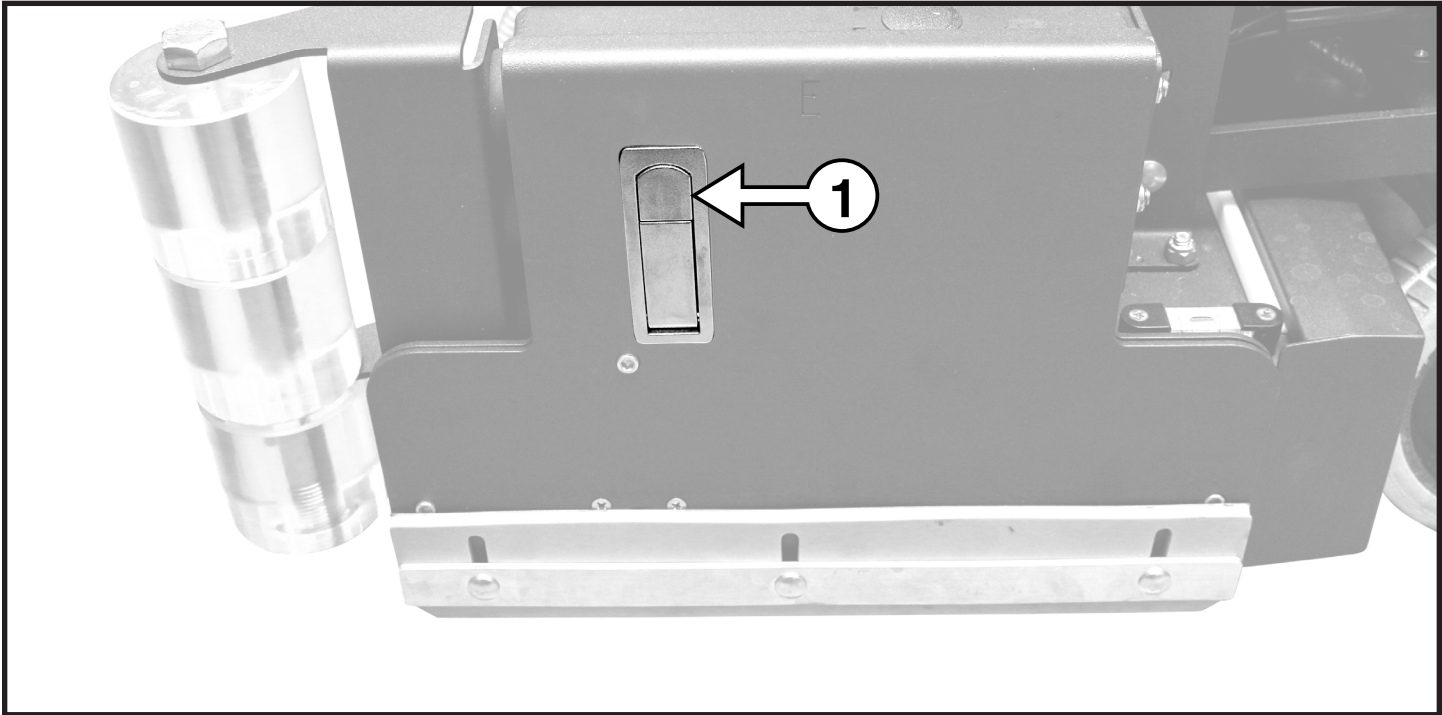

REMOVE EDGE PADS

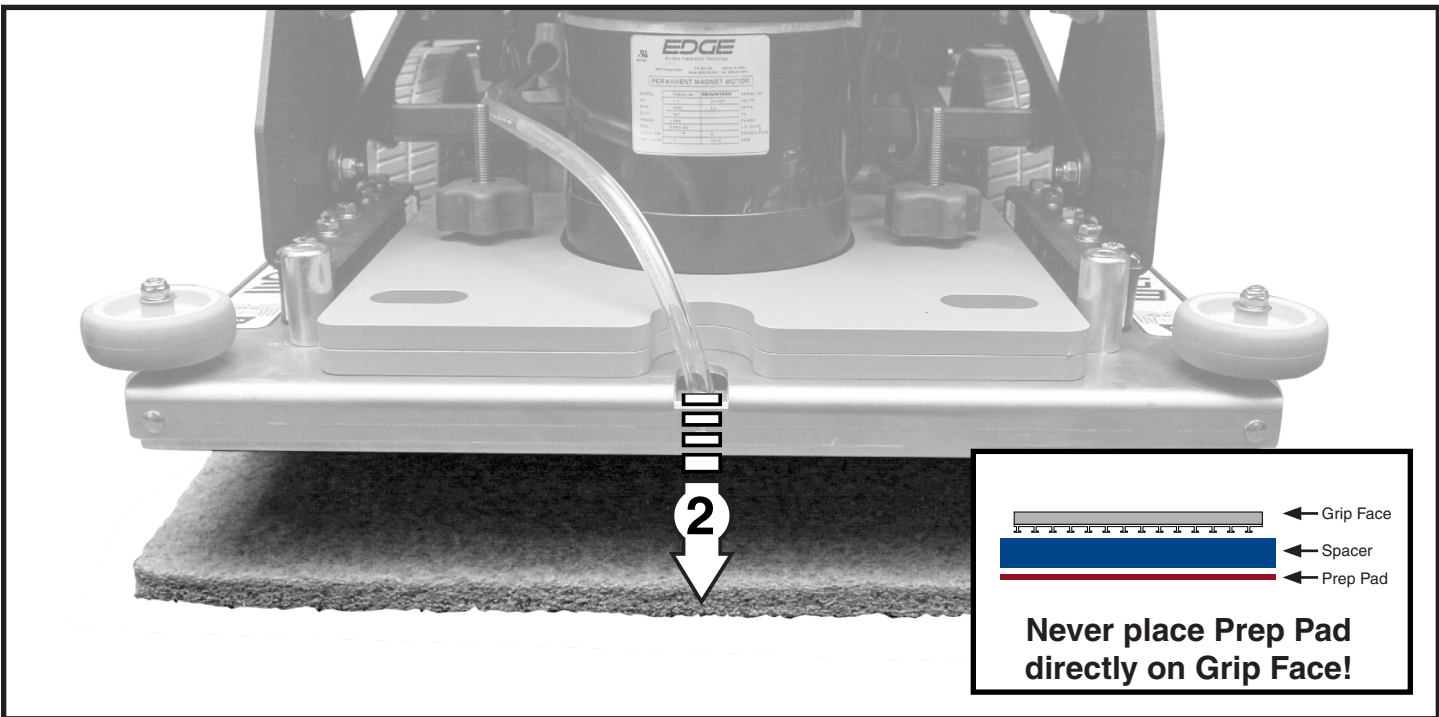
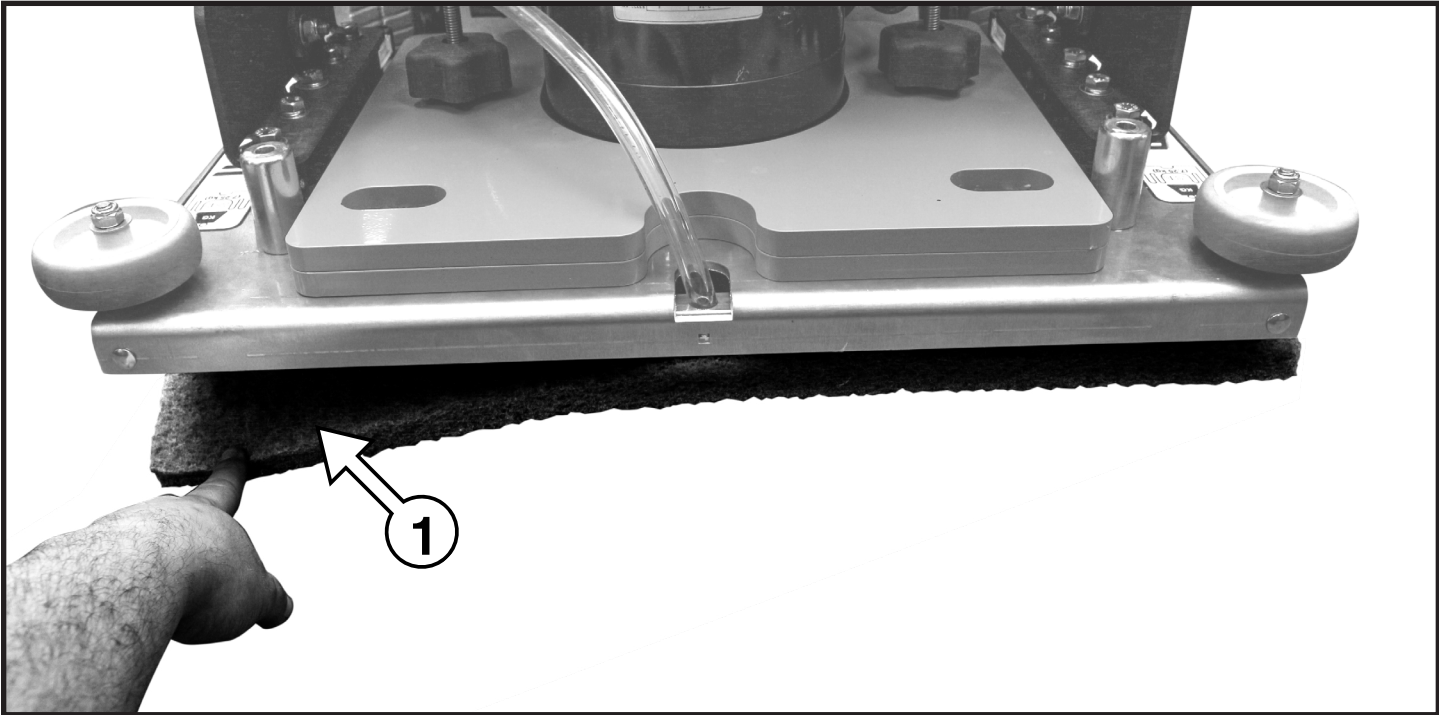
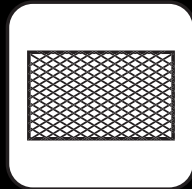

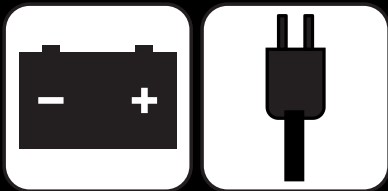

CHARGE BATTERIES

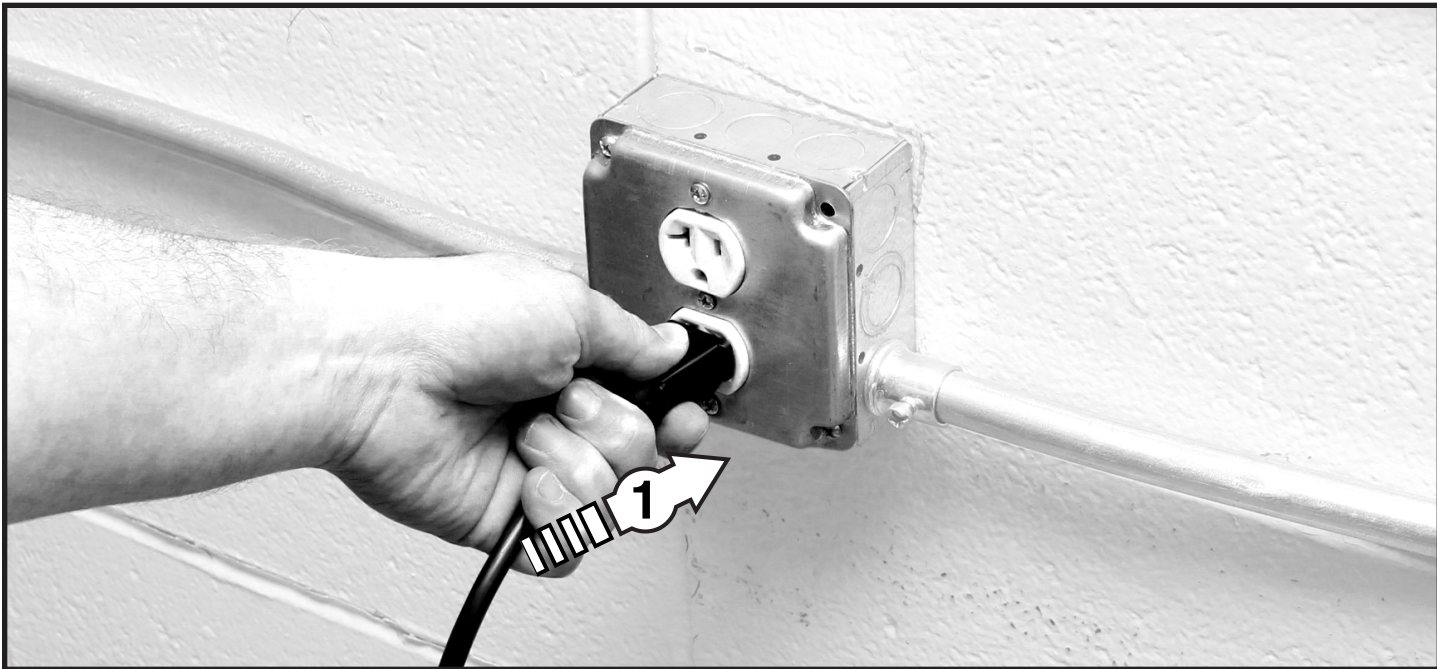

Please refer to OEM Charger Operating Instructions for more information.

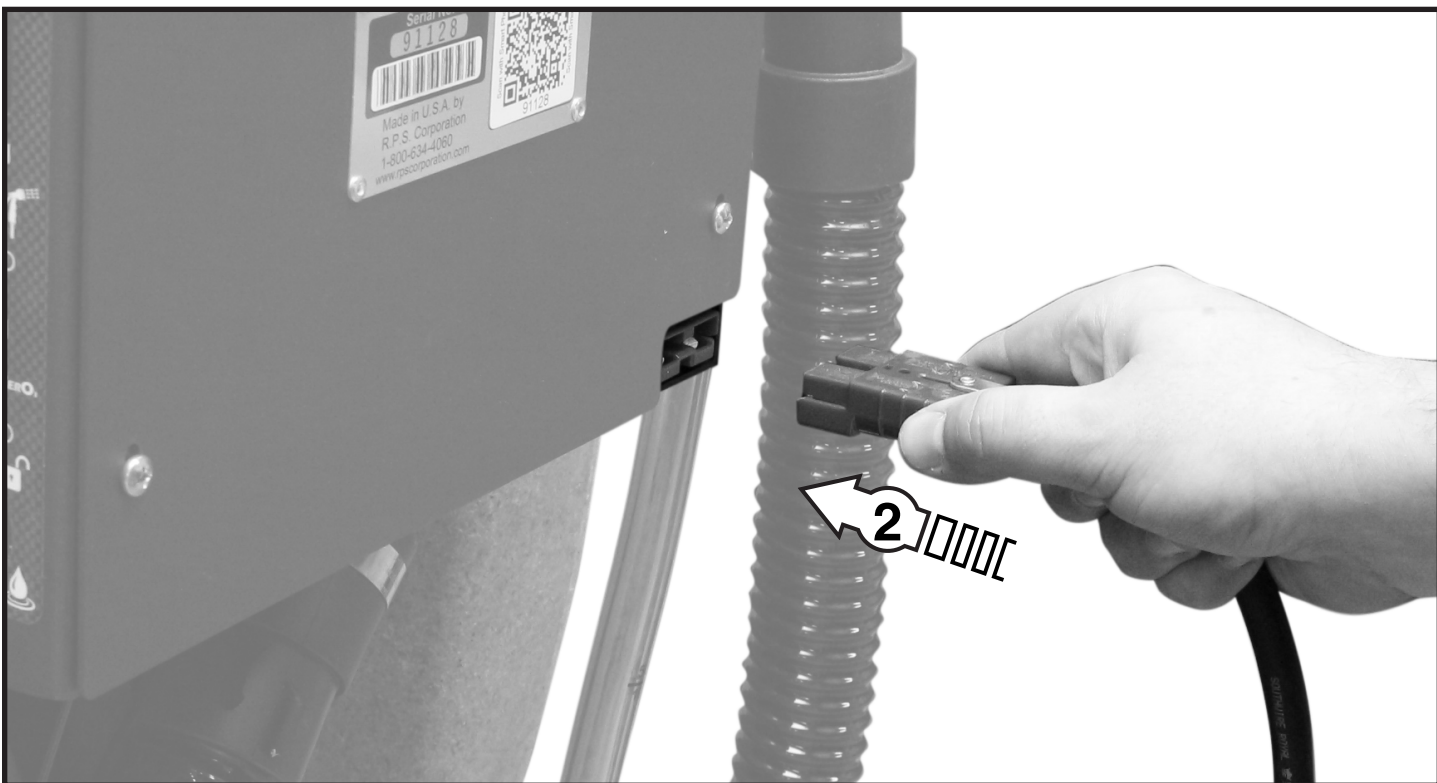

BATTERY CHARGERS



Console / WET / Domestic Chargers:



AC Power IN: 120VAC / 60Hz

DC Power OUT:

Sport: 24VDC / 12A

Carbon: 24VDC / 25A

Hero: 24VDC / 30A



Please refer to OEM Charger Operating Instructions for more information.

Onboard / AGM / International Chargers:

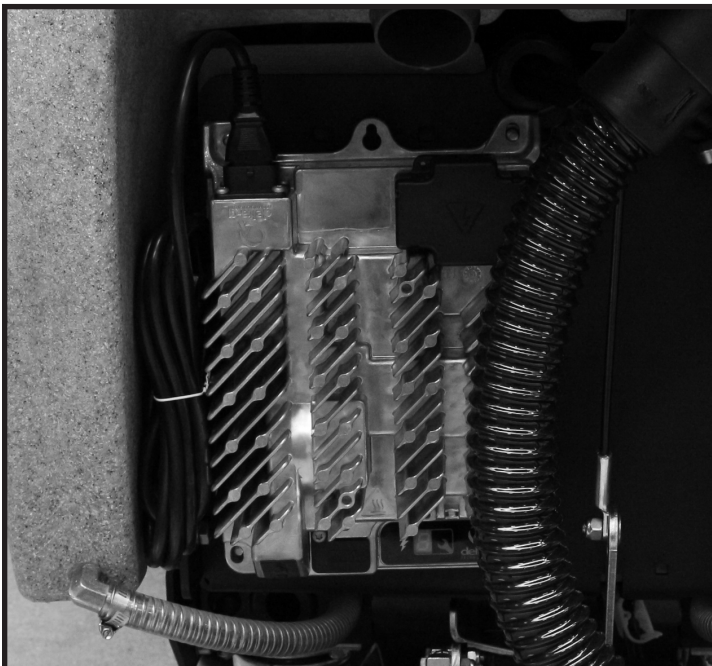

AC Power: 80-270VAC / 50-60Hz

DC Power OUT: 24VDC / 27A

Please refer to OEM Charger Operating Instructions for more information.



| CUSTOMER & MACHINE INFORMATION | | | |
|--------------------------------|----------|---------------|----------|
| Customer: | | | Email: |
| Address: | | | Phone: |
| City: | State: | Zip: | Contact: |
| Serial #: | Model #: | Work Order #: | |

NOTE: Start with Machine filled at least with ½ Tank of water. Turn ON Machine and Test Functionality of Machine

| CHECK OPERATION & CONDITION OF | IN SPEC | REPAIR | PROBLEM |
|--------------------------------------|---------|--------|---------|
| Key Switch | | | |
| Battery Gauge | | | |
| Deck Up / Down – Brush Switch | | | |
| Brush Pressure +/- Toggle (Optional) | | | |
| Vacuum Switch - ON / OFF | | | |
| Squeegee Lever - Up/Down | | | |
| Solution Switch - ON/OFF | | | |
| Solution Flow Lever +/- | | | |
| Green Drive Buttons - L & R | | | |
| Reverse Toggle Switch | | | |
| E-Stop (Optional) | | | |

NOTE: Drain Solution & Recovery Tank fully. Rinse out Recovery Tank

| CLEAN & INSPECT – SOLUTION TANK | IN SPEC | REPAIR | PROBLEM |
|---------------------------------|---------|--------|---------|
| Solution Fill Screen - Mesh | | | |
| Solution Fill Hose (Optional) | | | |
| Solution Inline Filter | | | |
| Vacuum Muffler Drain Hose | | | |
| Battery Drain Hose | | | |

| BRUSH CONDITION – SCRUB DECK | | | |
|---|-----------------|-----------------|------------------------|
| Deck Curtains/Wipers | Good | Worn | Needs Replacement |
| Brush Sockets: (2-Disk)/(4-Cylindrical) | Good | Worn | Needs Replacement |
| Brush Drivers: (2-Disk)/(4-Cylindrical) | Good | Worn | Needs Replacement |
| Scrub Brush Fiber Length | Brush 1 Length: | Brush 2 Length: | Rotated Brushes: Y / N |

| CLEAN & INSPECT – SCRUB DECK | IN SPEC | REPAIR | PROBLEM |
|---------------------------------|---------|--------|---------|
| Scrub Deck Linkage Pivot Points | | | |
| Scrub Deck Lift Actuator | | | |
| Scrub Deck Level (Orbital Only) | | | |
| Scrub Motor Wires | | | |

| CLEAN & INSPECT - SQUEEGEE | IN SPEC | REPAIR | PROBLEM |
|-----------------------------------|---------|--------|---------|
| Remove and Wipe off Squeegee | | | |
| Check and Rotate Blades as Needed | | | |
| Caster Wheels and Height | | | |
| Pitch Adjust | | | |
| Check Pivot and Knobs | | | |
| Squeegee Vac Hose | | | |

| CLEAN & INSPECT – RECOVERY TANK | IN SPEC | REPAIR | PROBLEM |
|---------------------------------|---------|--------|---------|
| Recovery Tank Lid & Gasket | | | |
| Vacuum Float Ball Screen | | | |
| Vacuum Box White Filter | | | |
| solution Site Tube | | | |

| CLEAN & INSPECT – DRIVE | IN SPEC | REPAIR | PROBLEM |
|----------------------------------|---------|--------|---------|
| Drive Wheels & Casters Condition | | | |
| Grease Caster Swivel | | | |

PM SHEET

| BATTERY #1 | HYDROMETER READING | WATER CLARITY (Circle One) | | WATER LEVEL (Circle One) | |
|------------|--------------------|----------------------------|------|--------------------------|--------|
| Cell A | | Clear | Dark | Overfilled | OK Low |
| Cell B | | Clear | Dark | Overfilled | OK Low |
| Cell C | | Clear | Dark | Overfilled | OK Low |
| Cell D/2A | | Clear | Dark | Overfilled | OK Low |
| Cell E/2B | | Clear | Dark | Overfilled | OK Low |
| Cell F/2C | | Clear | Dark | Overfilled | OK Low |
| BATTERY #2 | HYDROMETER READING | WATER CLARITY (Circle One) | | WATER LEVEL (Circle One) | |
| Cell A | | Clear | Dark | Overfilled | OK Low |
| Cell B | | Clear | Dark | Overfilled | OK Low |
| Cell C | | Clear | Dark | Overfilled | OK Low |
| Cell D/4A | | Clear | Dark | Overfilled | OK Low |
| Cell E/4B | | Clear | Dark | Overfilled | OK Low |
| Cell F/4C | | Clear | Dark | Overfilled | OK Low |

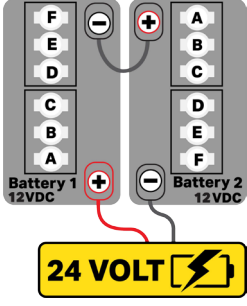
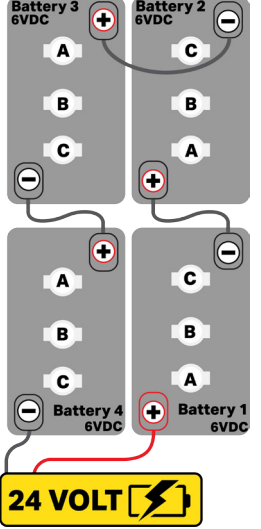
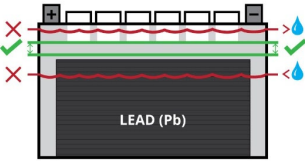
| CLEAN & INSPECT - BATTERIES | IN SPEC | REPAIR | PROBLEM |
|------------------------------|---------|--------|---------|
| Battery Terminals | | | |
| Battery Cables | | | |
| Torque Battery Nuts 11ft/lbs | | | |

| OPERATE & CONFIRM | IN SPEC | REPAIR | PROBLEM |
|--------------------------------|---------|--------|---------|
| Fill Solution Tank - ¾ Full | | | |
| Scrub & Dry | | | |
| Fine Tune Squeegee Adjustments | | | |

COMMENTS & RECOMMENDATIONS

| | | |
|------------------------|-------|------------|
| Servicing Distributor: | | |
| Technician's Name: | Date: | Signature: |
| Customer's Name: | Date: | Signature: |

MILITARY GRADE CENTRAL COMMAND - STATUS LIGHT CODES

Status Light Guide

Below is a list of self-help actions. Try to use this list before you contact your service agent. Go to the number in the list which matches the number of indicator light flashes and follow the instructions.

1 Flash



The battery needs charging, there is a bad connection to the battery or dependent on programming, may indicate that the battery lockout function is active and the controller is in a restricted mode of operation. Check the connections to the battery. If the connections are good, try charging the battery.

2 Flash



There is a bad connection to the motor. Check all connections between the motor and the controller.

3 Flash



The motor has a short circuit to a battery connection. Contact your service agent.

4 Flash



The battery charge level has fallen below the Battery Lockout Level and the controller is inhibiting certain machine functions. Charge the battery.

5 Flash



Not Used.

6 Flash



The controller is being inhibited from driving, this may be because the battery charger is connected.

7 Flash



A throttle fault is indicated. Make sure that the throttle is in the rest position before switching on the machine.

8 Flash



A controller fault is indicated. Make sure that all connections are secure.

9 Flash



The parking brakes have a bad connection. Check the parking brake and motor connections. Make sure the controller connections are secure.

10 Flash



An excessive voltage has been applied to the controller. This is usually caused by a poor battery connection. Check the battery connections.

TOUCH SCREEN ERROR CODES

| Error | Internal Label | Code | Type | Description | Action | Remedy |
|--|------------------------------|------|------|---|--|--------------------------|
| Vacuum motor current over software limit | VACUUM_SOFTWARE_OV | 49 | soft | The vacuum motor current has exceed the software limit | The vacuum motor is disabled | |
| Squeegee motor current over hardware limit | SQUEE_HARDWARE_OV | 50 | soft | The squeegee motor current has exceed the absolute hardware limit | The squeegee actuator is disabled | |
| | VALVE_FAULT | 51 | | | | |
| Open circuit detected in vacuum motor | VACUUM_OPEN_CIRCUIT | 52 | soft | An electrically open condition has been detected in the vacuum motor circuit | The vacuum motor is disabled | |
| | TRACT_RIGHT_NULL_ERROR | 53 | | | | |
| | TRACTION_OPEN_CIRCUIT | 54 | | | | |
| Open circuit detected in deck actuator | BRUSH_DECK_OPEN_CIRCUIT | 55 | soft | An electrically open condition has been detected in the deck actuator circuit | Brush, deck actuator and water/suds are disabled | |
| | TRAIL_TIME_OUT | 56 | | | | |
| | SOLENOID_WELDED_OTHER | 57 | | | | |
| | SOLENOID_CLOSE_LIMIT_WARNING | 58 | | | | |
| Squeegee motor stalled | SQUEE_STALLED_MOTOR | 59 | soft | An energized squeegee actuator is not moving | The squeegee actuator is disabled | |
| Deck actuator stalled | BRU_DECK_STALLED_MOTOR | 60 | soft | An energized deck actuator is not rotating | Brush, deck actuator and water/suds are disabled | |
| | PRECHARGE_FAILURE_OTHER | 61 | | | | |
| Brush motor stalled | BRUSH_STALLED_MOTOR | 62 | soft | An energized brush motor is not rotating | Brush, deck actuator and water/suds are disabled | |
| vacuum motor stalled | VACUUM_STALLED_MOTOR | 63 | soft | An energized vacuum motor is not rotating | The vacuum motor is disabled | |
| | LEFT_CURRENT_LIMIT | 64 | | | | |
| | RIGHT_CURRENT_LIMIT | 65 | | | | |
| Overheat MOSFET | THERMAL_CUTBACK_MOS | 66 | hard | The transport motor drive circuit has had an over temperature failure | The machine is disabled | |
| Battery over voltage | HIGH_BATTERY_PROTECT | 67 | hard | The battery voltage is above acceptable limits | The machine is disabled | check batteries / wiring |

TOUCH SCREEN ERROR CODES

| Error | Internal Label | Code | Type | Description | Action | Remedy |
|----------------------------------|--------------------------|------|-----------|---|---|---|
| | HARD_FAULT | 0 | | Flag used to define a show-stop-per failure requiring a power cycle | | |
| | SOFT_FAULT | 1 | | Flag used to define an error that may disable a device but keep the rest of the machine operational | | |
| | NO_ERROR | 0 | | Used internally | | |
| Bad Personality | BAD_PERSONALITY | 10 | hard/soft | Incompatible options programmed or a checksum failure | The machine is disabled or continues operating with factory default parameters | Check programming options and/or reprogram EEPROM |
| Initial throttle fault | INITIAL_THROTTLE_FAULT | 11 | soft | Throttle is engaged at power up preventing a successful return to idle state | Machine remains in a pre-idle condition until the active throttle condition goes away | Take your foot off the gas |
| | SHORT_CIRCUIT | 12 | hard | | | |
| Memory fault | EEPROM_READ_ERROR | 13 | hard/soft | An error was detected during an EEPROM read access | The machine is disabled or continues operating with factory default parameters | Cycle keyswitch. If problem persists change control board |
| Dead battery | LOW_BATTERY_PROTECT | 14 | hard | The battery voltage has dropped below NN.n Volts | The machine is disabled | Charge or replace batteries |
| Low battery charge | LOW_BATTERY_CHARGE | 15 | soft | The battery voltage has dropped below NN.n Volts and all but the transport motor have been disabled | All but the transport motor are disabled | Charge battery |
| Overheat CPU | THERMAL_CUTBACK_MCU | 16 | hard | The microcontroller hardware has had an over temperature failure | The controller is switched off | Keyswitch off, wait ten minutes, keyswitch on. If problem persists change control board |
| | PRECHARGE_FAILURE_TRA | 17 | | | | |
| Transport idle current fault | TRACT_LEFT_NULL_ERROR | 18 | hard | An abnormally high idle current has been detected in the transport motor (operational motor) | The machine is disabled | |
| Brush idle current fault | BRUSH_NULL_ERROR | 19 | soft | An abnormally high idle current has been detected in the brush motor (operational motor) | Brush, deck actuator and water/suds are disabled | |
| Vacuum idle current fault | VACUUM_NULL_ERROR | 20 | soft | An abnormally high idle current has been detected in the vacuum motor (operational motor) | Vacuum motor is disabled | |
| Squeegee idle current fault | SQUEEGEE_NULL_ERROR | 21 | soft | An abnormally high idle current has been detected in the squeegee motor (operational motor) | Squeegee motor is disabled | |
| | BRU_ADJ_OUT_OF_RANGE | 22 | soft | | | |
| Transport motor relay not open | SOLENOID_WELDED_TRA | 23 | hard | The main traction relay was detected closed during power on | The machine is disabled | Keyswitch off, wait ten seconds, keyswitch on. If problem persists change control board |
| Transport motor relay not closed | SOLENOID_DIDNT_CLOSE_TRA | 24 | hard | The main traction relay was detected open after being energized during power on | The machine is disabled | |
| Throttle fault | THROTTLE_FAULT | 25 | hard | An illegal voltage has been read from the throttle feedback circuit | The machine is disabled | Check throttle action and voltages |

TOUCH SCREEN ERROR CODES

| Error | Internal Label | Code | Type | Description | Action | Remedy |
|---|------------------------|------|------|--|--|-----------------|
| Brake fault | BRAKE_FAULT | 26 | hard | An illegal voltage has been read from the brake feedback circuit | The machine is disabled | |
| Alarm fault | ALARM_FAULT | 27 | soft | | | |
| Auxilliary output 1 fault | AUX_1_FAULT | 28 | soft | | | |
| Auxilliary output 2 fault | AUX_2_FAULT | 29 | soft | | | |
| Auxilliary output 3 fault | AUX_3_FAULT | 68 | soft | | | |
| Deck actuator idle current over limit | BRU_DECK_NULL_ERROR | 30 | soft | An abnormally high idle current has been detected in the deck actuator motor | Brush, deck actuator and water/suds are disabled | |
| Transport motor stalled | TRACTION_STALLED_MOTOR | 31 | hard | An energized transport motor is not rotating | | |
| Transport motor circuit current over limit | LEFT_DRAIN_OV | 32 | hard | There is excessive current in the transport motor drive circuit | | |
| Transport motor circuit current over limit | RIGHT_DRAIN_OV | 33 | hard | There is excessive current in the transport motor drive circuit | The machine is disabled | |
| Brush motor current over software limit | BRUSH_SOFTWARE_OV | 34 | soft | The brush motor current has exceed the software limit | Brush, deck actuator and water/suds are disabled | |
| Brush motor current over hardware limit | BRUSH_HARDWARE_OV | 35 | soft | The brush motor current has exceed the absolute hardware limit | Brush, deck actuator and water/suds are disabled | |
| Open circuit detected in brush motor | BRUSH_OPEN_CIRCUIT | 36 | soft | An electrically open condition has been detected in the brush motor circuit | Brush, deck actuator and water/suds are disabled | |
| | REGEN_CURRENT_EXCEEDED | 37 | | | | |
| | LEFT_DRAIN_FAULT | 38 | | | | |
| | RIGHT_DRAIN_FAULT | 39 | | | | |
| Transport motor current over hardware limit | LEFT_SOFTWARE_OV | 40 | hard | The transport motor current has exceed the absolute hardware limit | The machine is disabled | |
| Transport motor current over hardware limit | RIGHT_SOFTWARE_OV | 41 | hard | The transport motor current has exceed the absolute hardware limit | The machine is disabled | |
| | BRUSH_DRAIN_FAULT | 42 | | | | |
| 12VDC power supply outside acceptable limits | SUPPLY_OUT_OF_RANGE | 43 | hard | The 12VDC supply voltage is less tha 11.75V or greater than 12.25 volts | The machine is disabled | check batteries |
| | VALVE_OPEN_CIRCUIT | 44 | | | | |
| Deck actuator motor current over software limit | BRU_DECK_SOFTWARE_OV | 45 | soft | The deck actuator current has exceed the software limit | Brush, deck actuator and water/suds are disabled | |
| Vacuum motor current over hardware limit | VACUUM_HARDWARE_OV | 46 | soft | The vacuum motor current has exceed the software limit | The vacuum motor is disabled | |
| Deck actuator motor current over hardware limit | BRU_DECK_HARDWARE_OV | 47 | soft | The deck actuator current has exceed the absolute hardware limit | Brush, deck actuator and water/suds are disabled | |
| Squeegee motor current over software limit | SQUEE_SOFTWARE_OV | 48 | soft | The squeegee motor current has exceed the software limit | The squeegee actuator is disabled | |

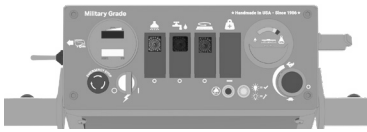

MILITARY GRADE SCHEMATIC

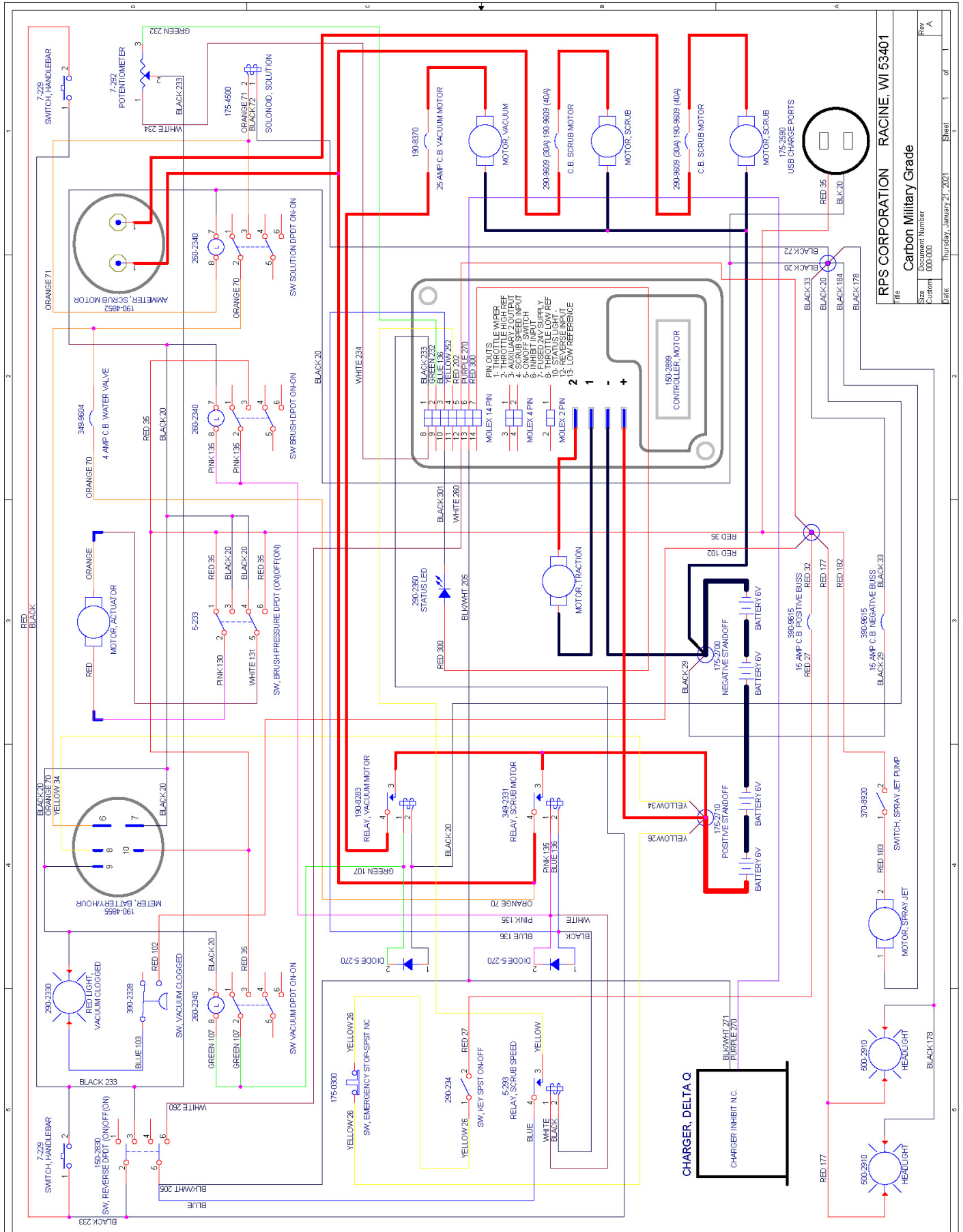

File: RPS CORPORATION RACINE, WI 53401
 Rev: Carbon Military Grade
 Size: Custom
 Part Number: 000-000
 Date: Thursday, January 21, 2021
 Sheet: 1 of 1

TOUCH SCREEN SCHEMATICS

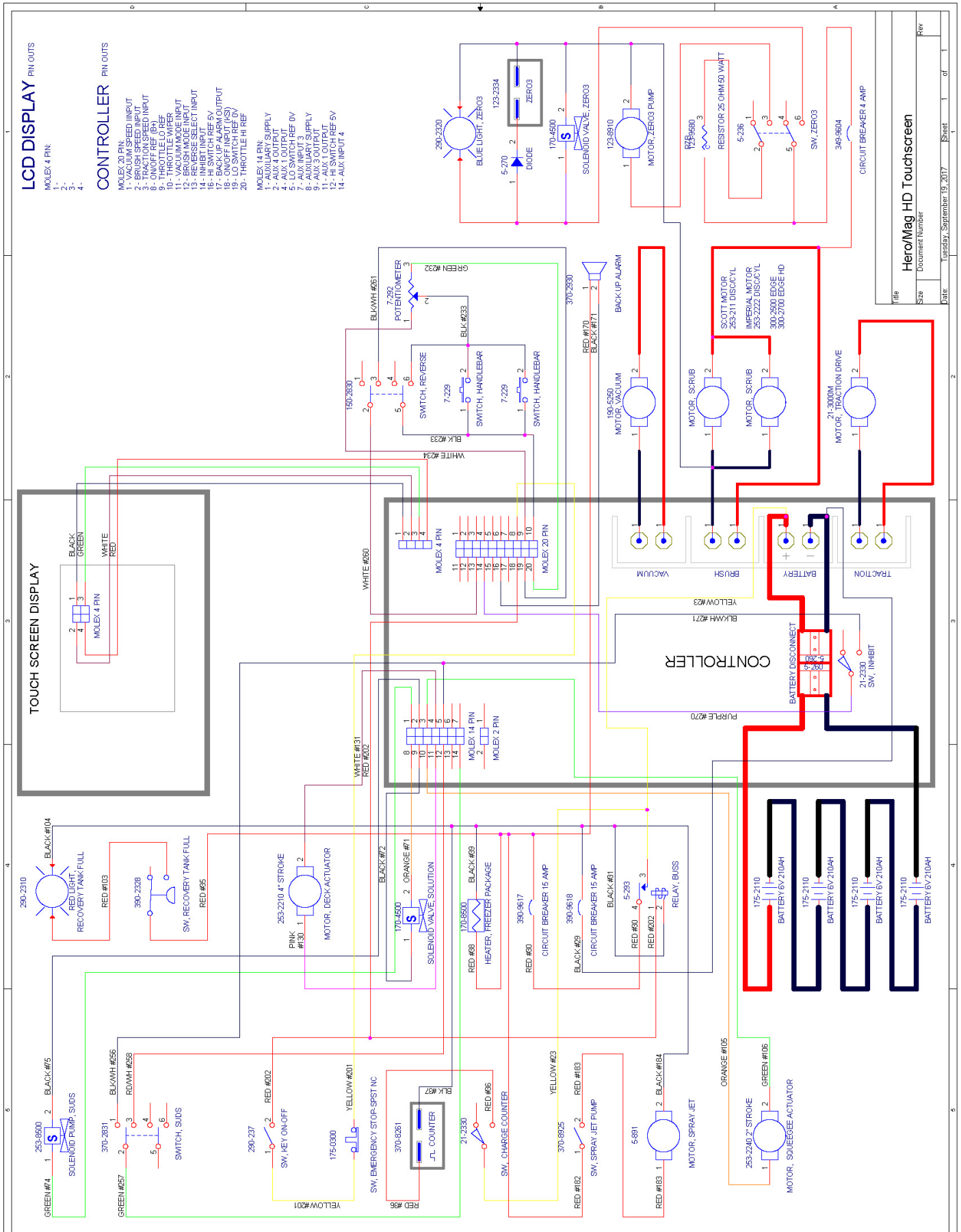
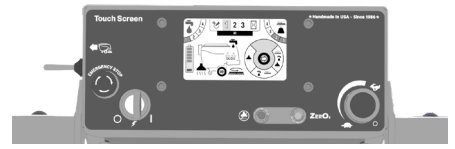

CONTROLLER PIN OUTS
MOLEX 14 PIN:
1- VACUUM SPEED INPUT
2- BRUSH SPEED INPUT
3- TRACTION SPEED INPUT
4- CHARGE INPUT
5- THROTTLE LO REF
6- THROTTLE HI REF
7- VACUUM MODE INPUT
8- REVERSE SELECT INPUT
9- INHIBIT INPUT
10- HI SWITCH REF 5V
11- HI SWITCH REF 5V
12- ON/OFF INPUT (AS)
13- ON/OFF INPUT (AS)
14- THROTTLE HI REF

MOLEX 20 PIN:
1- AUXILIARY SUPPLY
2- AUX 4 OUTPUT
3- TRACTION REF 5V
4- LO SWITCH REF 5V
5- LO SWITCH REF 5V
6- AUX INPUT 3
7- AUX INPUT 3
8- AUXILIARY SUPPLY
9- AUXILIARY SUPPLY
10- AUX 1 OUTPUT
11- AUX 1 OUTPUT
12- HI SWITCH REF 5V
13- HI SWITCH REF 5V
14- AUX INPUT 4

| | |
|-------|-----------------------------|
| file | Hero/Mag HD Touchscreen |
| Size | Document Number |
| Date | Tuesday, September 19, 2017 |
| Sheet | 1 of 1 |
| Rev | |

BLANK
THIS PAGE WAS INTENTIONALLY LEFT BLANK

BLANK
THIS PAGE WAS INTENTIONALLY LEFT BLANK

ROUND DISK BRUSHES:

NOTICE

The ## in Disk Column Denotes Desk Pad Size: 13" or 20"

| BRUSHES | DISK | LEVEL |
|----------------|----------|-----------|
| Super Grit | ##-382SS | Very High |
| Tough Grit | ##-382S | High |
| Midi Grit | ##-382C | Medium |
| Light Grit | ##-382PS | Moderate |
| Poly | ##-382P | Light |
| Nylon | ##-382N | Light |
| Tampico | ##-382T | Light |
| Pad Driver | ##-382D | |
| Diamond Driver | ##-382DD | |

ROUND DISK PADS:

NOTICE

The ## in Disk Column Denotes Desk Pad Size: 13" or 20"

| DISK PADS | DISK | LEVEL | COLOR |
|-------------|----------|-----------|-------|
| Super Black | ##-422BB | Very High | Black |
| Black | ##-422B | High | Black |
| Brown | ##-422BR | High | Brown |
| Green | ##-422G | Medium | Green |
| Blue | ##-422BL | Moderate | Blue |
| Red | ##-422R | Moderate | Red |
| White | ##-422W | Light | White |

CYLINDRICAL BRUSHES:

| BRUSHES | MODEL 25" CYLINDRICAL | LEVEL |
|------------|-----------------------|----------|
| Tough Grit | 236-697S | High |
| Midi Grit | 236-697C | Medium |
| Light Grit | 236-697PS | Moderate |
| Nylon | 236-697N | Light |
| Tampico | 236-697T | Light |

EDGE PADS AND SCREENS:

| DESCRIPTION | 24"×14" SCRUBDECK | 20"×14" SCRUBDECK | 28"×14" SCRUBDECK |
|--------------------------|-------------------|-------------------|-------------------|
| White Pad | N / A | EDGE-4005 | EDGE-4054 |
| Red Pad | EDGE-2404 | EDGE-4004 | EDGE-4053 |
| Blue Pad | EDGE-2403 | EDGE-4003 | EDGE-4052 |
| Green Pad | EDGE-2402 | EDGE-4002 | EDGE-4051 |
| Black Pad | EDGE-2401 | EDGE-4001 | EDGE-4050 |
| White Driver Pad | N / A | EDGE-4025 | EDGE-4058 |
| Tile/Grout Renovator Pad | N / A | EDGE-4018 | EDGE-4059 |
| Microfiber Pad | N / A | EDGE-4036 | EDGE-4060 |
| Dominator HD Strip Pad | N / A | EDGE-4006 | EDGE-4061 |
| Maroon ECO Prep Pad | EDGE-2407 | EDGE-4007 | EDGE-4062 |
| Remover Burnishing Pad | N / A | EDGE-4008 | EDGE-4063 |
| Porko Burnishing Pad | N / A | EDGE-4017 | |
| Velcro Pad | N / A | 300-4023 | |

EDGE GRIP FACE:

| DESCRIPTION | PART# |
|-------------------------------------|------------|
| 20", 24" & 28" Mighty Lok Grip Face | 300-01037Z |

V2.1 SQUEEGEE BLADE KITS & COMPLETE SQUEEGEE ASSEMBLIES:

| SQUEEGEE SIZE | 20" DISK DECKS | 26" DISK DECKS | 25" CYL. DECKS | 20" EDGE DECKS | 24" EDGE DECKS | 28" EDGE DECKS |
|---------------|----------------|----------------|----------------|----------------|----------------|----------------|
| 33" Squeegee | Standard | Standard | Standard | Standard | Standard | Standard |
| 37" Squeegee | Optional | Optional | Optional | Optional | Optional | Optional |

| SQUEEGEE SIZE | LINATEX BLADE KIT | COMPLETE SQUEEGEE ASSEMBLIES |
|---------------|-------------------|------------------------------|
| 33" Squeegee | 433-721L | 233-2181 |
| 37" Squeegee | 437-721L | 237-2181 |

| SQUEEGEE MATERIAL: | USED FOR: |
|--------------------|--|
| LINATEX | Provides best wear and tear resistance. Not designed for use with harsh chemicals. |

NOTICE

Squeegee blade kits include (1) Rear Blade, (1) Front Blade, and (2) Caster Wheels with hardware.

NOTICE

Squeegee Assemblies (complete) listed above all come with Linatex blades.

NOTICE

Size is shown as a decal at the top of the steel squeegee body on all squeegee's.

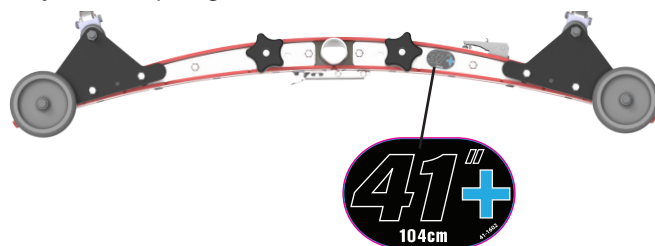

ROUND DISK BRUSHES:

NOTICE

The ## in Disk Column Denotes Desk Pad Size: 13" or 14"

| BRUSHES | DISK | LEVEL |
|----------------|----------|-----------|
| Super Grit | ##-382SS | Very High |
| Tough Grit | ##-382S | High |
| Midi Grit | ##-382C | Medium |
| Light Grit | ##-382PS | Moderate |
| Poly | ##-382P | Light |
| Nylon | ##-382N | Light |
| Tampico | ##-382T | Light |
| Pad Driver | ##-382D | |
| Diamond Driver | ##-382DD | |

ROUND DISK PADS:

NOTICE

The ## in Disk Column Denotes Desk Pad Size: 13" or 14"

| DISK PADS | DISK | LEVEL | COLOR |
|-------------|----------|-----------|-------|
| Super Black | ##-422BB | Very High | Black |
| Black | ##-422B | High | Black |
| Brown | ##-422BR | High | Brown |
| Green | ##-422G | Medium | Green |
| Blue | ##-422BL | Moderate | Blue |
| Red | ##-422R | Moderate | Red |
| White | ##-422W | Light | White |

CYLINDRICAL BRUSHES:

| BRUSHES | MODEL 25" CYLINDRICAL | MODEL 29" CYLINDRICAL | LEVEL |
|------------|--------------------------|--------------------------|----------|
| Tough Grit | 236-697S | 276-697S | High |
| Midi Grit | 236-697C | 276-697C | Medium |
| Light Grit | 236-697PS | 276-697PS | Moderate |
| Nylon | 236-697N | 276-697N | Light |
| Tampico | 236-697T | 276-697T | Light |

EDGE PADS AND SCREENS:

| DESCRIPTION | 24"×14" SCRUBDECK | 28"×14" SCRUBDECK |
|--------------------------------|----------------------|----------------------|
| White Pad | N/A | EDGE-4054 |
| Red Pad | EDGE-2404 | EDGE-4053 |
| Blue Pad | EDGE-2403 | EDGE-4052 |
| Green Pad | EDGE-2402 | EDGE-4051 |
| Black Pad | EDGE-2401 | EDGE-4050 |
| White Driver Pad | N/A | EDGE-4058 |
| 60 Grit Sand Screen | N/A | EDGE-4059 |
| 80 Grit Sand Screen | N/A | EDGE-4060 |
| 100 Grit Sand Screen | N/A | EDGE-4061 |
| 120 Grit Sand Screen | N/A | EDGE-4062 |
| 150 Grit Sand Screen | N/A | EDGE-4063 |
| 80 Grit Sand Paper | N/A | N/A |
| 100 Grit Sand Paper | N/A | N/A |
| 400 Grit Diamond Polishing Pad | N/A | EDGE-4013 |

| | | |
|---------------------------------|-----------|-----------|
| 800 Grit Diamond Polishing Pad | N/A | EDGE-4014 |
| 1500 Grit Diamond Polishing Pad | N/A | EDGE-4015 |
| 3000 Grit Diamond Polishing Pad | N/A | EDGE-4016 |
| 6000 Grit Diamond Polishing Pad | N/A | EDGE-4070 |
| Tile/Grout Renovator Pad | N/A | EDGE-4048 |
| Dominator HD Strip Pad | N/A | EDGE-4055 |
| Maroon ECO Prep Pad | EDGE-2407 | EDGE-4056 |

EDGE GRIP FACE:

| DESCRIPTION | PART# |
|------------------------------|------------|
| 24"-28" Mighty Lok Grip Face | 300-01037Z |

V2.1 SQUEEGEE BLADE KITS & COMPLETE SQUEEGEE ASSEMBLIES:

| SQUEEGEE SIZE | 26" DISK DECKS | 28" DISK DECKS | 25" CYL. DECKS | 29" CYL. DECKS | 24" EDGE DECKS | 28" EDGE DECKS |
|---------------|----------------|----------------|----------------|----------------|----------------|----------------|
| 37" Squeegee | Standard | Standard | Standard | Standard | Standard | Standard |
| 41" Squeegee | Optional | Optional | Optional | Optional | Optional | Optional |

| SQUEEGEE SIZE | LINATEX BLADE KIT | COMPLETE SQUEEGEE ASSEMBLIES |
|---------------|-------------------|------------------------------|
| 37" Squeegee | 437-721L | 37-2181 |
| 41" Squeegee | 441-721L | 41-2181 |

| SQUEEGEE MATERIAL: | USED FOR: |
|--------------------|--|
| LINATEX | Provides best wear and tear resistance. Not designed for use with harsh chemicals. |

NOTICE

Squeegee blade kits include (1) Rear Blade, (1) Front Blade, and (2) Caster Wheels with hardware.

NOTICE

Squeegee Assemblies (complete) listed above all come with Linatex blades.

NOTICE

Size is shown as a decal at the top of the steel squeegee body on all squeegee's.

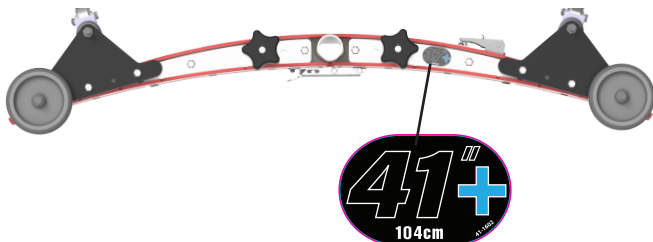

ROUND DISK BRUSHES:

NOTICE

The ## in Disk Column Denotes Desk Pad Size: 15", 16" or 17"

| BRUSHES | DISK | LEVEL |
|----------------|----------|-----------|
| Super Grit | ##-382SS | Very High |
| Tough Grit | ##-382S | High |
| Midi Grit | ##-382C | Medium |
| Light Grit | ##-382PS | Moderate |
| Poly | ##-382P | Light |
| Nylon | ##-382N | Light |
| Tampico | ##-382T | Light |
| Pad Driver | ##-382D | |
| Diamond Driver | ##-382DD | |

ROUND DISK PADS:

NOTICE

The ## in Disk Column Denotes Desk Pad Size: 15", 16" or 17"

| DISK PADS | DISK | LEVEL | COLOR |
|-------------|----------|-----------|-------|
| Super Black | ##-422BB | Very High | Black |
| Black | ##-422B | High | Black |
| Brown | ##-422BR | High | Brown |
| Green | ##-422G | Medium | Green |
| Blue | ##-422BL | Moderate | Blue |
| Red | ##-422R | Moderate | Red |
| White | ##-422W | Light | White |

CYLINDRICAL BRUSHES:

| BRUSHES | MODEL 29" CYLINDRICAL | MODEL 33" CYLINDRICAL | LEVEL |
|------------|-----------------------|-----------------------|----------|
| Tough Grit | 276-697S | 316-697S | High |
| Midi Grit | 276-697C | 316-697C | Medium |
| Light Grit | 276-697PS | 316-697PS | Moderate |
| Nylon | 276-697N | 316-697N | Light |
| Tampico | 276-697T | 316-697T | Light |

EDGE PADS AND SCREENS:

| DESCRIPTION | 28"×14" SCRUBDECK | 32"×14" SCRUBDECK |
|--------------------------|-------------------|-------------------|
| White Pad | EDGE-4054 | EDGE-5005 |
| Red Pad | EDGE-4053 | EDGE-5004 |
| Blue Pad | EDGE-4052 | EDGE-5009 |
| Green Pad | EDGE-4051 | EDGE-5002 |
| Black Pad | EDGE-4050 | EDGE-5001 |
| White Driver Pad | EDGE-4058 | N / A |
| 60 Grit Sand Screen | EDGE-4059 | N / A |
| 80 Grit Sand Screen | EDGE-4060 | N / A |
| 100 Grit Sand Screen | EDGE-4061 | EDGE-5028 |
| 120 Grit Sand Screen | EDGE-4062 | EDGE-5029 |
| 150 Grit Sand Screen | EDGE-4063 | N / A |
| Tile/Grout Renovator Pad | EDGE-4048 | N / A |
| Dominator HD Strip Pad | EDGE-4055 | N / A |
| Maroon ECO Prep Pad | EDGE-4056 | EDGE-5007 |
| Remover Burnishing Pad | EDGE-4057 | EDGE-5008 |
| Porko Burnishing Pad | EDGE-4047 | N / A |
| Velcro Pad | 300-4024 | N / A |

EDGE GRIP FACE:

| DESCRIPTION | PART# |
|------------------------------|------------|
| 28"-32" Mighty Lok Grip Face | 300-01037Z |

V2.1 SQUEEGEE BLADE KITS & COMPLETE SQUEEGEE ASSEMBLIES:

| SQUEEGEE SIZE | 30" DISK DECKS | 34" DISK DECKS | 29" CYL. DECKS | 33" CYL. DECKS | 28" EDGE DECKS | 32" EDGE DECKS |
|---------------|----------------|----------------|----------------|----------------|----------------|----------------|
| 41" Squeegee | Standard | Optional | Standard | Optional | Standard | Optional |
| 45" Squeegee | Optional | Standard | Optional | Standard | Optional | Standard |

| SQUEEGEE SIZE | LINATEX BLADE KIT | COMPLETE SQUEEGEE ASSEMBLIES |
|---------------|-------------------|------------------------------|
| 41" Squeegee | 441-721L | 41-2181 |
| 45" Squeegee | 445-721L | 45-2181 |

| SQUEEGEE MATERIAL: | USED FOR: |
|--------------------|--|
| LINATEX | Provides best wear and tear resistance. Not designed for use with harsh chemicals. |

NOTICE

Squeegee blade kits include (1) Rear Blade, (1) Front Blade, and (2) Caster Wheels with hardware.

NOTICE

Squeegee Assemblies (complete) listed above all come with Linatex blades.

NOTICE

Size is shown as a decal at the top of the steel squeegee body on all squeegee's.

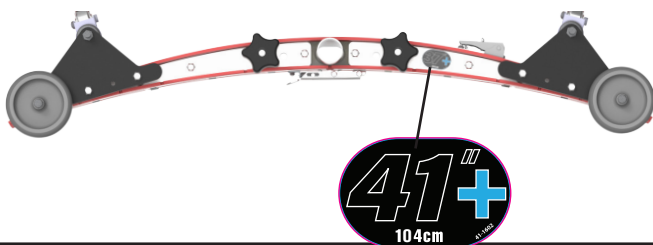

Central Command Decals

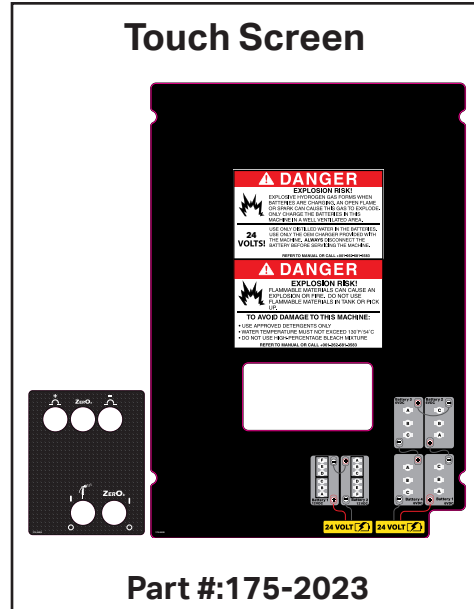

Models / Options / Squeegee Size Decals



BLANK
THIS PAGE WAS INTENTIONALLY LEFT BLANK



1711 South Street
Racine, WI 53404
www.tomcatequip.com
1-262-681-6470